

OP ORDERS

1 JAN 1987
CHANGE 3

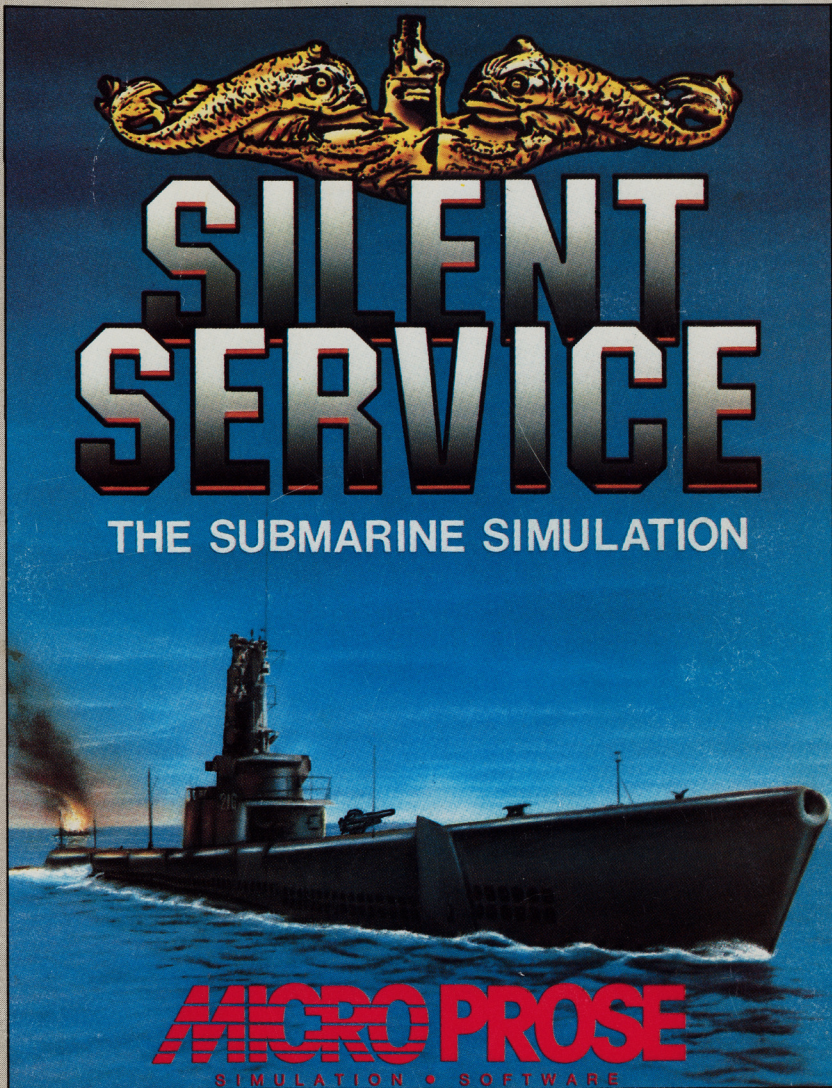

**TACTICAL OPERATIONS
MANUAL**

MICRO PROSE™
SIMULATION • SOFTWARE

P R E S E N T S



**SILENT
SERVICE™**
THE SUBMARINE SIMULATION

©Copyright 1985, 1986 by MicroProse Software Inc.
All Rights Reserved
120 Lakefront Drive, Hunt Valley, MD 21030

Silent Service is a trademark of MicroProse Software Inc.

Commodore 64 and Amiga, Atari, Apple and MacIntosh, and IBM
are registered trademarks of Commodore Business Machines Inc., Atari Inc.,
Apple Computer Inc., and International Business Machines, Inc., respectively.

A NOTE FROM THE DESIGNER...

This simulation was inspired by the book "CLEAR THE BRIDGE" by Richard H. O'Kane, commander of the USS TANG during World War II. My hope was to capture in this simulation some of the tense situations, quick decision making, and decisive action so characteristic of World War II undersea combat. The design of this product included extensive research, examination of actual WWII submarines, and assistance of both current and former submariners. The software includes a number of specially designed subsystems, including a

dynamic map generation module (loosely based on the mathematics of fractal curves), simultaneous processing of data for five separate graphic battle station screens, and a detailed simulation of Japanese anti-submarine tactics.

We hope that this simulation will provide enjoyment for the new player, a sustained challenge for the avid gamer, and perhaps a glimmer of recognition to all those who knew or heard tales of those intrepid American undersea warriors of the Second World War.

Happy Hunting!

Sid Meier

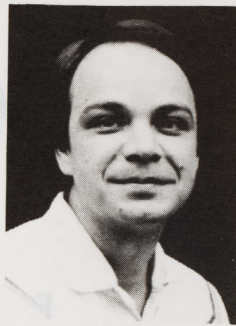

SID MEIER
Author of
F-15 STRIKE EAGLE

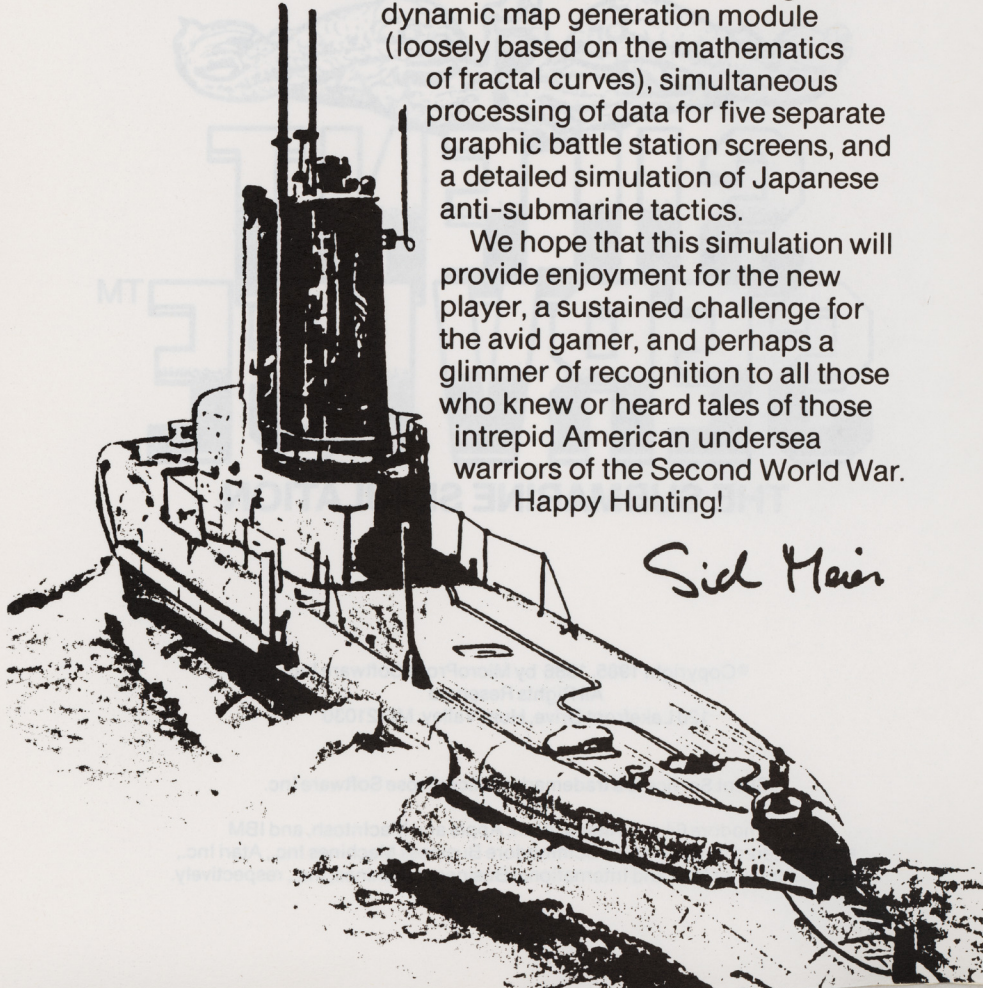

TABLE OF CONTENTS

KEYBOARD COMMANDS	INSIDE FRONT
MISSION BRIEFING	4
INTRODUCTION	4
QUICK START	4
PRE-MISSION TARGET IDENTIFICATION PRACTICE (IMPORTANT: READ CAREFULLY)	5
LOADING INSTRUCTIONS	5
OPTIONS	7
SIMULATION SPECIFICATIONS	9
CONTROLS	9
SUBMARINE CONTROLS	9
COMBAT CONTROLS	10
TIME AND SCALE CONTROLS	11
CONNING TOWER MENU SCREEN	12
BATTLE STATION SCREENS	13
WAR PATROL NAVIGATION MAP BATTLE STATION	13
MAPS AND CHARTS BATTLE STATION	14
BRIDGE BATTLE STATION	14
PERISCOPE/BINOCULARS BATTLE STATION	15
INSTRUMENTS AND GAUGES BATTLE STATION	16
DAMAGE REPORTS BATTLE STATION	17
SUB CONTROL DIAGRAM AND STATUS AREA	18
MESSAGES AND SOUNDS	18
TIME SCALING	19
END OF MISSION, SCORING AND RANKS	19
SIMULATION SCENARIOS	20
CONVOY ACTION SCENARIOS	20
WAR PATROL SCENARIOS	23
MAP OF THE SOUTH PACIFIC	24
SUBMARINE TACTICAL OPERATIONS	31
APPROACH	31
TORPEDOES	32
ESCAPE	33
JAPANESE CONVOYS	35
JAPANESE TACTICS	35
TACTICAL SITUATION PLOTS	36
PLAYING TIPS	39
SUBMARINE SPECIFICATIONS	40
CAPABILITIES	41
STANDARD EQUIPMENT	41
EQUIPMENT INNOVATIONS	41
SUBMARINE WARFARE IN THE SOUTH PACIFIC	42
U.S. SUBMARINES IN THE SOUTH PACIFIC	43
DESIGNER'S NOTES	46
CREDITS	47

INTRODUCTION

SILENT SERVICE is a detailed simulation of World War II submarine missions in the Pacific. It places you into the role of submarine captain, presents you with the same information, problems, and resources available to an actual sub captain. Included are numerous scenarios, options, and play variations. Five detailed battle station screens, numerous commands, and realistic graphics and sound effects combine to provide a dramatic level of realism and playability.

As is detailed later, US submarines played a crucial role in stemming the tide of Japanese imperialism and winning the war in the Pacific. The primary mission of the American Silent Service was to take on the Japanese Navy in their home waters and to neutralize the Japanese Merchant Marine. As submarine commander in this elite force, you will be evaluated based on the number and types of ships which you sink.

The first group of scenarios recreate actual historical situations and require a variety of different tactics. They are useful for becoming acquainted with the mechanics of this simulation, practicing specific situations, or for quick games. The real test of a submariner's skill however, are the Patrol scenarios. Here you will encounter an almost infinite variety of situations as you seek out and attack enemy convoys. With a limited number of torpedoes and fuel, your goal is to sink a maximum tonnage of enemy shipping and bring your sub successfully back to base.

As an accurate simulation of a real-life situation, there are numerous details, subtleties, and features included in the simulation. The beginning player may safely defer the consideration of some of these factors until a few games are completed. The "Quick Start" section below is designed to allow experienced players to boot the program and play without reading the extensive documentation which follows. However, your enjoyment of this simulation will be enhanced by an understanding of the tactics, missions, equipment, and history of submarine combat as detailed in the remainder of this document.

QUICK START

Like most people you are probably anxious to load up this product and get started! We offer this "quick start" to get you going with what we call the JG perspective. This is the viewpoint of a new Lieutenant JG (Junior Grade), eager for battle, anxious to experience first-hand the challenge of submarine combat. When you decide to investigate this simulation in-depth, you will need to thoroughly review the contents of this operations manual. But, for you JG's, grab your seabag, follow the short sea orders below, and let's go!

1. Review the SUBMARINE CONTROLS and COMBAT CONTROLS sections to give you an idea of how to handle your submarine.
2. Look over the CONNING TOWER MENU and BATTLE STATION SCREENS sections to understand the options available to you on each screen.
3. Locate your loading instructions and load the program into your computer.
4. Choose Torpedo/Gun Practice or a Convoy Action scenario. (Stick to scenario 1 or 2 until you learn to maneuver and attack with your submarine.)
5. Choose difficulty level 1 (trainee).
6. Turn off all reality level factors.
7. Good luck!

TARGET IDENTIFICATION PRACTICE

A vital skill which each sub captain must possess is the ability to recognize and identify enemy targets. If you select one of the dangerous Patrol Mission scenarios you will be given a chance to refresh your target identification skills. Look up the ship requested (example: Japanese "Type I" Destroyer) in this Operation Manual. Determine which of the four ship silhouettes displayed on the screen matches the silhouette in the Operations Manual. Type the number of the matching silhouette (1, 2, 3, 4). If you correctly identify the ship you may proceed on your patrol. If you are incorrect, you will be re-assigned for further training and will proceed to Torpedo/Gun Practice at Midway Island.

LOADING INSTRUCTIONS

COMMODORE 64/128

Before loading, be sure your joystick is installed in port 2, nearest the back of the computer.

If you have a Commodore 128, place the computer in C-64 mode by holding down the COMMODORE key while turning on the computer. C-64 and 128: type LOAD"";8,1 then press RETURN.

Leave the game disk in the disk drive at all times.

The function keys "F1" through "F8" refer to the keys f1-f8 on the far right of the keyboard.

At some point, you may wish to clear the Submariner's Hall of Fame rankings. To do this, boot the machine, type LOAD "CLEAR";8 then press RETURN. When the computer responds with "READY", type RUN then press RETURN.

COMMODORE AMIGA

Start your Amiga with KickStart (version 1.1 or higher), then eject the KickStart disk and insert Silent Service. It will load automatically. Leave the disk in the drive during the game. You can use either the mouse (in port 1) or a joystick (in port 2) to play the game.

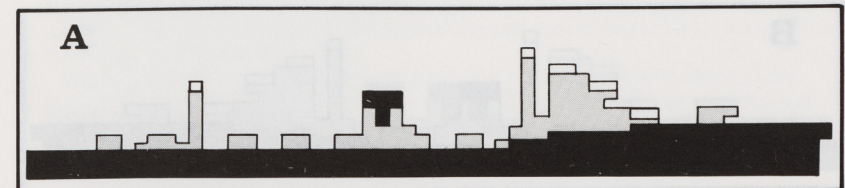

ATARI XL/XE

This program requires an ATARI 400/800/1200 XL/XE computer with at least 48K of memory and a disk drive. To load the program, remove all cartridges from the computer, insert the game disk in your disk drive, and turn on your system's power. The joystick should be connected to the first joystick connector.

The function keys "F1" through "F8" refer to SHIFT-1 (!) through SHIFT-8 (@). The "F7" function may also be selected by pressing the START key.

ATARI ST

If your computer has TOS already installed in ROM, simply place the Silent Service disk in your computer and turn it on. Leave the disk in the drive during play.

If you have an early-version ST with no ROM TOS chips, insert your Atari TOS disk in the drive first, then turn on the computer. When the desktop appears, remove the TOS disk and insert the Silent Service disk. Then press the ESC key to display the contents of the Silent Service disk. When the contents appear, use the **left** button to double-click on the folder called AUTO. The AUTO folder will open to show a program called SERVICE.PRG. Double-click on this program and you will start Silent Service.

APPLE II Family

Plug in your joystick. You must have a joystick to play the game.

Press the CAPS LOCK key. Caps lock must be DOWN to play the game.

Place the game disk in the disk drive and turn on the computer. The game boots automatically. Leave the disk in the drive while playing.

The "F7" function key is either the joystick fire button or the RETURN key, depending on the selection screen. Follow the instructions on the screen.

To get the latest information on program and instructions updates, boot your Apple with a DOS 3.3 disk. Then remove it, insert your game disk, type RUN MANUAL UPDATES and press RETURN.

IBM PC or TANDY 1000

NOTE: Your IBM PC must have a color graphics card to play this game. You may use either keyboard or joystick to play.

Place the game disk in your disk drive and turn on the computer. The disk will boot automatically. Leave the disk in the drive.

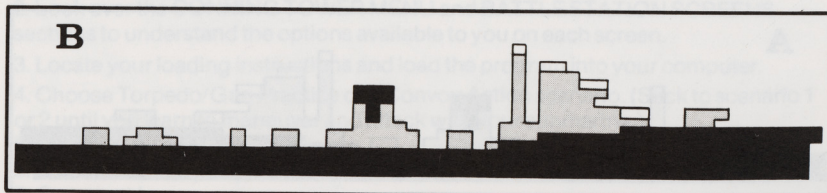
**OPTIONS**

Upon loading, you will be allowed to select the scenario, options, and skill factors you wish to use.

SCENARIOS

There are three types of scenarios. "Torpedo/Gun Practice" places you outside the American base at Midway Island. Four old cargo ships are anchored there as torpedo and gunnery practice targets. The second set of scenarios: "Convoy Actions", recreate various actual submarine attacks on a convoy. "War Patrols", allow you to command an entire patrol, beginning at the submarine bases at Midway, Brisbane, or Fremantle; continuing through a number of convoy actions; and concluding with a return to base.

SKILL LEVELS

You may select from one of four skill levels: "MIDSHIPMAN", "LIEUTENANT", "COMMANDER" or "CAPTAIN". The skill level affects the accuracy of torpedo runs, damage sustained from depth charge attacks, the skills of enemy lookouts and sonar operators, as well as other factors. The "MIDSHIPMAN" level is designed to provide a challenge for beginning players. The "COMMANDER" level is designed to be historically accurate. The "CAPTAIN" level is intended for the expert sub driver. Press 1, 2, 3 or 4 to change the skill level.

REALITY LEVELS

In addition, you may customize the simulation with various "reality levels". Each level introduces an element which makes the simulation both more realistic and more difficult. To select the reality levels, use the joystick to move the flashing asterisk and press the trigger to toggle the YES/NO indicator.

1) LIMITED VISIBILITY

If this level is selected enemy ships which are beyond radar/sonar range will not appear on the map displays. Enemy ships which were detected but have moved out of range will blink slowly at their last known position. If this level is not selected, all enemy ships will appear on the map displays regardless of their range or location.

2) CONVOY ZIG-ZAGS

If this level is selected enemy convoys will "zig-zag" (change course) at regular intervals. If this level is not selected, cargo ships will steam straight ahead unless they are attacked by torpedoes or encounter land masses.

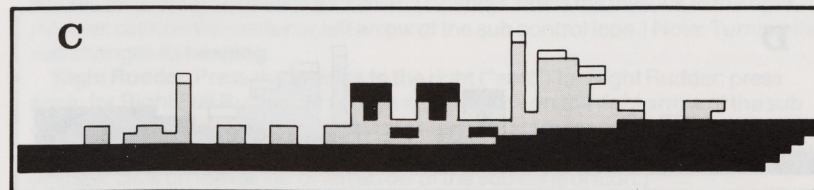

3) DUD TORPEDOES

If this level is selected some of your torpedoes may be duds, especially during the years 1942-1943. Dud torpedoes may hit the enemy but will not explode, only the splash will be seen.

4) PORT REPAIRS ONLY

If this level is selected repairs will no longer be accomplished automatically while in battle or on patrol. Once an item of major equipment is damaged, it may not be repaired.

5) EXPERT DESTROYERS

If this level is selected certain enemy convoys will be escorted by "expert" destroyers. These escorts are more persistent and have better trained sonar operators.

6) CONVOY SEARCH

If this level is selected convoys will not always appear within radar range. You will need to search them out. Far off convoys are best sighted by performing a 360 degree periscope/binocular sweep of the horizon.

7) ANGLE-ON-BOW INPUT

If this level is selected the computer will no longer calculate the "Angle on the Bow" for torpedo shots. You must enter the angle yourself based on periscope observations. Be sure you understand the workings of the Torpedo Data Computer before attempting this level. Recommended for experienced players only.

DIFFICULTY LEVELS

The skill level and reality levels you select combine to produce an overall difficulty factor from 1 to 9. This difficulty factor and the tonnage which you sink will determine your ranking in the "Submariner's Hall of Fame" at the conclusion of your mission.

Once you are satisfied with the skill and reality levels, press "F7" to load the remainder of the game and begin play.

Additional data may be loaded at this time. When loading is completed you will appear in the conning tower (or the Patrol Navigation Map if you selected a War Patrol scenario) and the action will begin!

TERMINOLOGY

Port: The left side of the ship.

Starboard: The right side of the ship.

Bearing: The direction you are looking.

Heading: The direction your ship is going.

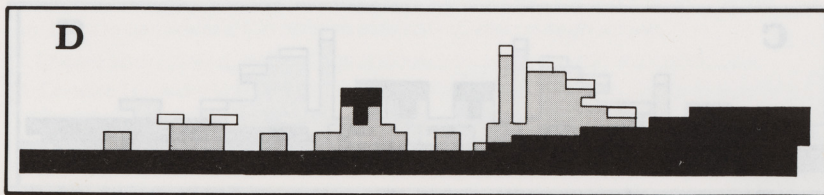
**CONTROLS**

All of the following controls have keyboard equivalents that can be found on the Keyboard Commands chart on the inside front cover of the manual.

WAR PATROL CONTROLS

See the WAR PATROL BATTLE STATION description.

SUBMARINE CONTROLS

Submarine controls are available primarily at the *Maps and Charts* or *Gauges and Instruments* battle stations.

Raise or Lower Periscope: Press the "P" key on the keyboard. (Atari ST and Amiga: You can also select the periscope icon on the mouse menu.) This command raises scope if it's down, and lowers it if it's up. It also sets the visual **bearing** (the direction you're looking) to be the same as the sub's **heading** (the direction the sub is going). You can use the periscope (in daylight only) down to a maximum depth of 44 feet.

Throttle (Speed): Keys "0" through "4" control the sub's speed. "0" = all stop (silent running); "1" = 1/3 speed; "2" = 2/3 speed; "3" = Full speed; "4" = Flank speed. (Atari ST and Amiga: You can also select speed by clicking on the throttle icon in the mouse menu.)

Reverse: Press "R" on the keyboard to reverse the engines. (Atari ST and Amiga: You can reverse engines by clicking on the "Reverse" icon in the mouse menu.) To change speed while in reverse, adjust the throttle, then select Reverse again. Note that the turning effect of the rudders is reversed when the sub is moving in reverse.

Dive: To dive, pull down or toward you ("south") on the joystick. (If using a mouse, click on the downward arrow of the sub control icon.) This causes the sub to increase its depth. When you have reached the desired depth, cancel the command by pushing up or away ("north") on the joystick. (Mouse: Click the center or upward arrow of the sub control icon.)

In scenarios before August, 1943 your maximum safe depth is 300 feet; after August, 1943 your maximum safe depth is 425 feet.

Surface: To surface, push up or away ("north") on the joystick. (If using a mouse, click on the upward arrow of the sub control icon.) This causes the sub to rise toward the surface. When you have reached the desired depth, cancel the command by pulling down or toward you ("south") on the joystick. (Mouse: Click the center or downward arrow of the sub control icon.)

Left Rudder: Press the joystick to the left ("west") for Left Rudder; press again for Full Left Rudder. (If using a mouse, click on the left arrow of the sub control icon.) This turns the sub toward the left (port); if looking on the *Map* screen, you will see the sub turn counterclockwise. To cancel, press the joystick to the right. (Mouse: click on the center or left arrow of the sub control icon.) Note: Turning the sub changes its **heading**.

Right Rudder: Press the joystick to the right ("east") for Right Rudder; press again for Right Full Rudder. (If using a mouse, click on the right arrow of the sub control icon.) This turns the sub toward the right (starboard); if looking on the *Map* screen, you will see the sub turn clockwise. To cancel, press the joystick to the left. (Mouse: click on the center or left arrow of the sub control icon.)

Cancel: To cancel all turn and dive commands, press the RETURN key. (Atari ST and Amiga can cancel by clicking in the center of the sub control icon.)

Blow Emergency Tanks: Press CONTROL E to blow emergency tanks. This can halt an otherwise fatal drive, and usually brings your sub to the surface. You may perform this only once per engagement.

COMBAT CONTROLS

Combat controls are available primarily when at the Periscope/Binoculars battle station.

Identify: Press the "I" key to identify the target under the crosshairs in the periscope/binoculars. (Atari ST and Amiga can identify by clicking in the ID area.)

Fire Torpedo: Press the "T" key to fire a torpedo at the target under the white crosshairs. (Atari ST and Amiga can fire by clicking on the torpedo icon.) Bow or aft tubes will be selected automatically depending on which faces the target more directly. Note that four torpedoes and gun shells (total) may be active at any one time. If a fifth shot is fired before the first is finished, the first will end prematurely and the new shot is launched. See the "Torpedoes" section of SUBMARINE TACTICAL OPERATIONS for more details.

Fire Deck Gun: Press the "G" key to fire the four-inch deck gun at the target under the white crosshairs. (Atari ST and Amiga can fire the gun by clicking on the deck gun icon.) The gun may be fired only when your sub is on the surface. The range is automatically set to the TDC range of the target at which you are aiming. See the "Deck Gun" section of SUBMARINE TACTICAL OPERATIONS for more details.

Increase Gun Deflection: Press the "+" key to increase deck gun deflection by 25 yards (Atari XL/XE: Press the ">" key). Each additional press adds 25 more yards to the deflection. You want to increase deflection when the target is moving away from you.

Decrease Gun Deflection: Press the "-" key to decrease deck gun deflection by 25 yards (Atari XL/XE: Press the "<" key). Each additional press subtracts 25 more yards from the deflection. You want to decrease deflection when the target is moving toward you.

Rotate View Left: Press the joystick left to rotate the view left on the *Periscope/Binoculars* or *Bridge* screens. (Mouse: place the mouse arrow on the left handle or left horizon and hold down the **left** button.) To increase the rotation speed, hold down the fire button while pressing the joystick over. (Mouse: hold down **both** buttons.) Rotating the view changes its **bearing**.

Rotate View Right: Press the joystick right to rotate the view right on the *Periscope/Binoculars* and *Bridge* screens. (Mouse: place the mouse arrow on the right handle or right horizon and hold down the **right** button.) To increase the rotation speed, hold down the fire button while pressing the joystick over. (Mouse: hold down **both** buttons.)

Angle-on-Bow Entry: If playing with this reality level, you should enter an angle-on-bow value from -180 to +180 before you fire a torpedo at the target. Enter a negative value if the sub's line of sight is to the left (port) of the target's heading (from the target's standpoint); use a positive value if the sub's line of sight is to the right (starboard) of the target's heading.

To begin the entry, press the "A" key. Change the angle shown by holding the joystick left or right: left for negative, right for positive (IBM: use the left/right cursor keys.) When you have reached your chosen angle, press the fire button. You may then fire a torpedo at that angle.

(Atari ST and Amiga: The AOB gauge appears directly beneath the viewing area. Use the mouse to point to a position on the scale, or use the joystick to move the marker on the scale. In either case, you'll see the exact angle-on-bow value in the digital readout below. Press the **left** mouse button or fire button to select a value.)

Release Debris: Press the "?" key to release debris and oil. These rise to the surface and may convince the enemy your sub has sunk. You may release debris only once per engagement.

TIME AND SCALE CONTROLS

Wait (Pause): Press the "W" key to pause the simulation — press any key to continue. You may also pause by selecting the Conning Tower screen.

Faster Time: Press the "F" key to increase the time scale, thus causing the simulation to move more rapidly. (Amiga only: click on the clock icon.) Each subsequent key press doubles the speed, to a maximum of 32 times real time speed (three key presses). See the "Time Scaling" section for more details.

Normal Time: Press the "N" key to return to the normal time scale. (Amiga only: click on the "N" below the clock icon.) You automatically return to normal time when detected by the enemy or when you fire a torpedo or the deck gun.

Zoom: Press the "Z" key to expand the situation map on the *Maps and Charts* screen. (Atari ST and Amiga: Click on the large square in the Zoom icon.) This gives you a closer look at nearby ships and terrain.

Un-zoom: Press the "X" key to compress the situation map on the *Maps and Charts* screen. (Atari ST and Amiga: Click on the small square in the Zoom icon.) This gives you a wider view of ship locations and land areas.

Software Concealment: (IBM only.) Press the "'" (apostrophe) key to display a bogus "PROCESSING PLEASE WAIT" message. This locks out the keyboard until the "'" key is pressed again. If you're playing at the office and the boss walks by, this can be very handy!

Volume Control: (IBM only.) Press the "V" key to turn off the engine sounds; press again to turn off all sounds. A third press will restore all sounds.

WAR PATROL

Some versions of the software refer the user to this page of the manual for information on the War Patrol Navigation Map screen. In this edition, that information can be found on page 13.

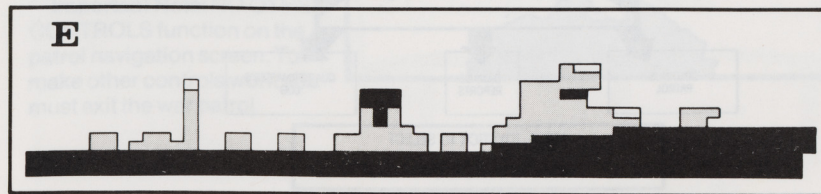

CONNING TOWER MENU SCREEN

The conning tower screen acts as a menu screen — from this screen, you may select any of the five detailed battle station screens: the attack periscope, the bridge, the map plot, critical gauges and instruments, and damage reports (all of these are described in the "Battle Stations" section below). Use the joystick or mouse to position the captain at the desired battle station, then press the trigger. Center — Periscope; Up — Bridge; Left — Instruments and Gauges; Right — Maps and Charts; Down — Damage Reports. To access the *Binoculars* battle station you must first go to the *Bridge*, then press the fire button again. You may return to the conning tower from any screen but the *Bridge* by pressing the fire button (Atari St or Amiga: The **right** mouse button).

When you are at the conning tower screen, the simulation is paused. Note that some selections are unavailable under certain conditions, e.g. the bridge is unavailable if you are under water, etc.

You may also select two special functions from this screen. If you are playing a Training or Convoy Action scenario, the "End of Game" function (joystick or mouse down and left) will end your mission. If you are playing a War Patrol scenario, the "Continue Patrol" function (joystick or mouse down and left) ends the current convoy battle and returns you to the patrolling screen. You cannot end the battle if you are being tracked by enemy escorts, have torpedoes active, or if an enemy ship is still sinking.

The "Quartermaster's Log" option (joystick or mouse down and right) is used to review your accomplishments so far in this patrol.

If you prefer, keystroke commands may be used to make these selections (key commands **must** be used if playing the IBM version without a joystick). See KEYBOARD COMMANDS on the inside front cover. All other keyboard commands are **ignored** on the conning tower until you select a battle station.

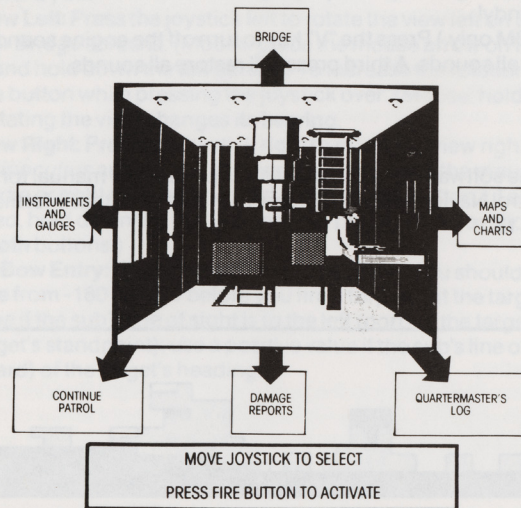

BATTLE STATION SCREENS

SILENT SERVICE contains multiple Battle Station screens. On each screen different information is available and different commands can be entered. The battle stations represent the main locations from which the captain manages the battle as his sub goes into action. Not all controls are operable from all screens: be sure to note what controls are available on each screen.

WAR PATROL NAVIGATION MAP BATTLE STATION (War Patrol scenarios only)

When you select a **War Patrol** scenario you start out on this screen, which displays a map of the western Pacific Ocean. You are free to explore any area of the map. Your ship is a tiny black dot near your starting port of Fremantle on Exmouth Gulf, Brisbane, or Midway (see the map on pages 24 and 25). The patrol screen simulates the time required to proceed from your base to enemy-controlled waters as well as the patrolling activity between engagements. (A typical patrol lasted up to two months.)

Moving on the War Patrol map: If using a joystick, push the stick in the direction you wish to move. If using a mouse, your ship will always move toward the mouse arrow. Move the arrow to the desired location and the ship will sail toward it.

Time moves quickly while patrolling. The ocean or screen border changes from light to dark blue to represent day and night (Apple version: text messages indicate passage of time).

Finding the Enemy: When the ocean or screen border turns red, you've spotted a convoy (Apple version: "CONVOY SIGHTED" message appears). Press the fire button (or either mouse button) to exit from patrol if you want to engage in battle. Note that enemy ships are generally found along the heavily travelled convoy routes (see map on pages 24 and 25) and close to land. Valuable tanker and troop ship convoys are more likely to be found near Japan.

If you get the urge to explore a particular area of the map, you may do so, even if no convoys have been sighted and you are not at your base. Simply press the fire button to exit war patrol.

Getting Home: The submarine bases at Midway Island, Fremantle and Brisbane are indicated by flashing dots.

When you have reached your base and the ocean or screen border turns green, you can return to port (Apple version: "AT BASE" message appears). Press the fire button (or the **right** mouse button) to end the patrol and record your score in the Submariner's Hall of Fame.

Important Note: NO OTHER CONTROLS function on the patrol navigation screen. To make other controls work you must exit the war patrol.

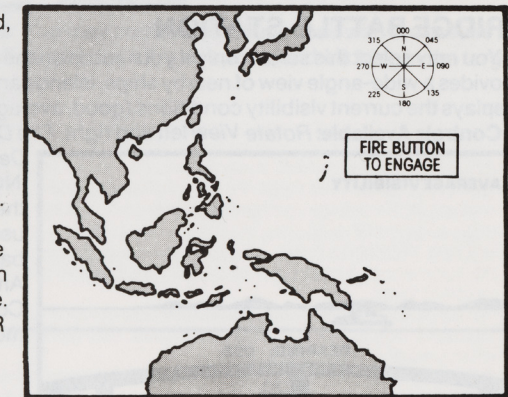

MAPS AND CHARTS BATTLE STATION

The maps and charts screen displays information available from the navigator and the tracking party. Map information, visual sightings, radar and sonar are combined on this screen to show the location of your submarine, torpedoes, and all known enemy ships. Your submarine is represented by a black dot, torpedoes and enemy ships are white dots, green areas represent land masses and islands. NOTE: sometimes there are enemy ships out there that you have not yet detected. These undetected ships do NOT appear on the map. Your lookouts aren't always reliable — it's wise to leave the maps battle station and look around the horizon with the periscopes and binoculars yourself.

If an enemy ship is no longer within sighting range, a dot will flash slowly at its last known position. If more ships and torpedoes are active than the tracking party can handle, the most distant objects may be dropped from the map.

Zoom: You may enlarge or shrink the scale of the map to any of four levels of detail by using the Z and X keys (optional for Atari ST and Amiga: click on the Zoom/Un-zoom icon with the left button). The initial map shows the entire Western Pacific. The Patrol Area map shows a 500 by 300 mile area. Zoom again and you will see the Navigation Map, which shows 60 by 40 miles. The most detailed map is the Attack Plot map, which shows an area of 8 miles by 5 miles. On the Attack Plot, ships are displayed with small "tails" which indicate the direction each ship is moving (Apple version: the ships have no tails, but each has a small dot at the bow that indicates which way the ship is headed).

Controls Available: All *Submarine* and *Time and Scale* controls, plus "Release Debris."

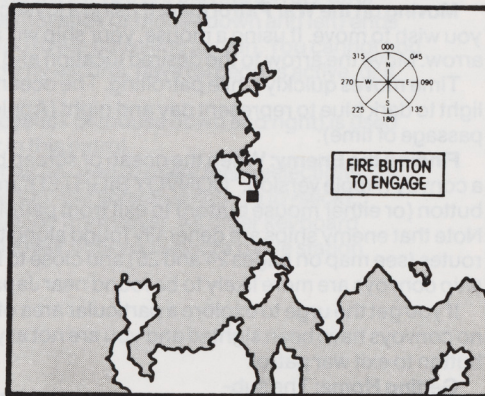

BRIDGE BATTLE STATION

You may select this screen only if your sub is on the surface. The bridge screen provides a wide-angle view of nearby ships, islands and coastline. This screen also displays the current visibility conditions (good, average or poor).

Controls Available: *Rotate View* left and right, *Fire Deck Gun* and *Increase and Decrease Deck Gun Deflection*. (NOTE: firing the deck gun from the bridge is not recommended — use the *Periscope/Binoculars* battle station.) On Atari ST and Amiga versions, the Submarine Controls are available in the mouse menu.

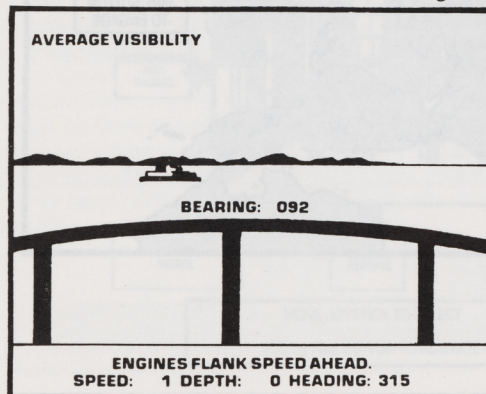

Bearing: Notice that the "Bearing" changes as you rotate your view. Bearing is the direction in which you are looking expressed in compass degrees. Bearing 000 indicates you are looking North, 090 is East, 180 is South and 270 is West.

PERISCOPE/BINOCULARS BATTLE STATION

This screen displays the view through the attack periscope during daylight/dusk/dawn and the view from the bridge Target Bearing Transmitter binoculars at night. The viewing area shows an enlarged image of visible ships and land. This screen may be selected when the sub is on the surface, or at periscope depth (44 feet or less) in daylight. (The attack periscope did not transmit enough light to be used at night.)

Controls Available: All *Combat* controls, plus *Wait*, *Faster Time* and *Normal Time*. (Atari ST and Amiga: Submarine Controls are available in the mouse menu.)

Torpedo Data Computer:

When the crosshairs turn white, the Torpedo Data Computer is activated and target tracking is displayed. The TDC displays the range to the target, the target's speed, "angle on the bow," the computed gyro lead angle necessary to hit the ship, and the target's course. (Course is not available if you have selected the "Enter Angle-On-Bow" reality level.) You may fire a torpedo by pressing the "T" key, fire the deck gun by pressing the "G" key, or request target information from the identification party by pressing the "I" key. (Atari St or Amiga: You may control these functions with the mouse by selecting the torpedo or deck gun icons to fire weapons, and clicking in the target ID area for identification.)

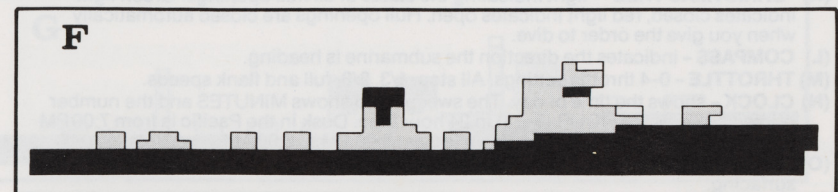
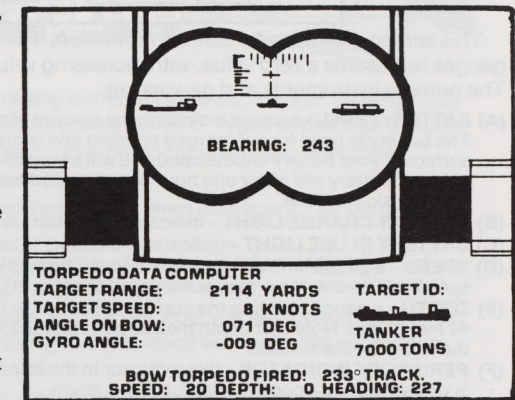

INSTRUMENTS AND GAUGES

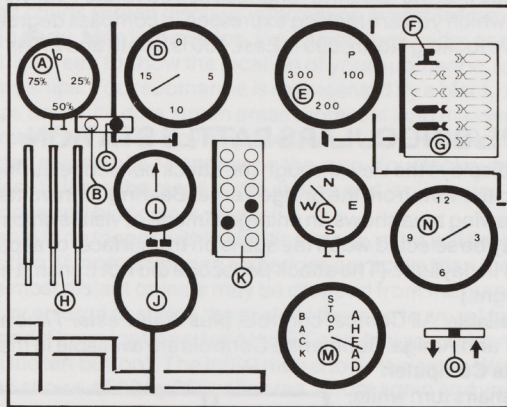

This screen displays vital status information. The straight up position for all gauges represents a zero value, with increasing values in the clockwise direction. The primary instruments and gauges are:

- (A) **BATTERY LEVEL** - a gauge indicating the amount of electricity remaining in the battery. The battery is used for submerged cruising and is gradually recharged when on the surface. If your battery is exhausted you will be unable to move while underwater. A fully charged battery will allow one hour of high speed maneuvering underwater, five or six hours at slow speeds.
- (B) **BATTERY CHARGE LIGHT** - indicates the battery is being charged.
- (C) **BATTERY IN USE LIGHT** - indicates the battery is being drained.
- (D) **SPEED** - a gauge indicating the sub's speed through the water. Maximum surface speed is 20 knots, maximum submerged speed is 10 knots.
- (E) **DEPTH** - a gauge showing the current depth below the surface. Periscope depth is 44 feet or less. Note that depth measured in feet below the surface; zero depth means the sub is on the surface.
- (F) **PERISCOPE INDICATOR** - this indicator in the upper left of the torpedo status box is white if the periscope is raised, black if down.
- (G) **TORPEDO READY INDICATOR** - a series of lights indicating which forward and aft torpedoes tubes are ready for firing. Green indicates ready, black indicates empty. Torpedo reloading is performed automatically and requires about 10 game minutes per tube. The green number under each column of torpedoes indicates how many bow/aft torpedoes remain in addition to those already in the tubes. The red number above the indicator indicates how many deck gun shells remain.
- (H) **FUEL LEVELS** - three vertical tubes showing the diesel fuel levels in the three main tanks. The diesel fuel floats on top of the water. The tubes show the amount of fuel (black) and water (white) in each tank. Full tanks allowed for 50 to 60 days cruising.
- (I) **DEPTH UNDER THE KEEL** - a gauge showing the depth from your sub to the ocean bottom. When this gauge reads zero you will run aground. Maximum reading on this gauge is 500 feet.
- (J) **WATER TEMPERATURE** - a gauge showing the temperature of the water outside the submarine. A blue dial hand indicates that the submarine is below a thermal gradient layer.
- (K) **"CHRISTMAS TREE"** - light indicating the status of all hull openings. Green light indicates closed, red light indicates open. Hull openings are closed automatically when you give the order to dive.
- (L) **COMPASS** - indicates the direction the submarine is heading.
- (M) **THROTTLE** - 0-4 throttle settings. All stop, 1/3, 2/3, full and flank speeds.
- (N) **CLOCK** - shows the time of day. The sweep hand shows MINUTES and the number printed below is the HOUR (0-23) in 24 hour time. Dusk in the Pacific is from 7:00 PM (Hour 19) to 8:00 PM (Hour 20), dawn is from 5:00 AM to 6:00 AM.
- (O) **DIVE BUBBLE** - a horizontal tube showing whether the submarine is diving or surfacing.

DAMAGE REPORTS BATTLE STATION

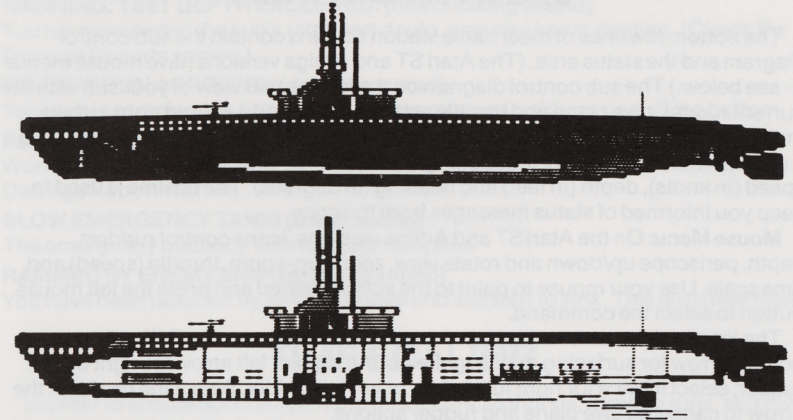

This screen indicates the nature of any damage to the submarine. Damage may be caused by depth charge attacks or enemy gunfire. Types of damage include: **Bow/Aft torpedo damage:** these torpedo tube doors have been damaged. The torpedoes will not fire.

Periscope damage: the periscope housing has been damaged. The periscope cannot be lowered or raised.

Dive Plane damage: the bow and stern dive planes have been damaged. The submarine will only dive or surface at half its normal rate.

Fuel Leaking: the external fuel tanks are leaking. Fuel will be consumed at twice the normal rate. In addition, fuel rising to the surface will make the submarine easier to detect by enemy destroyers.

Engine Damage: the main diesel engines are damaged. Surface speeds are reduced by half.

Machinery Damage: internal pumps and engines are damaged. The extra noise make the enemy's sonar tracking easier.

Battery Damage: batteries are used up at twice the normal rate when submerged. If the "Port Repairs Only" reality level is not selected, repairs are attempted by the crew automatically.

If your sub is taking on water, the leakage rate is indicated in gallons per second (GPS). Leakage will often cause your sub to descend, although the dive planes may be able to counter-act the dive. This information is provided in the top right hand side of the Damage Reports Screen.

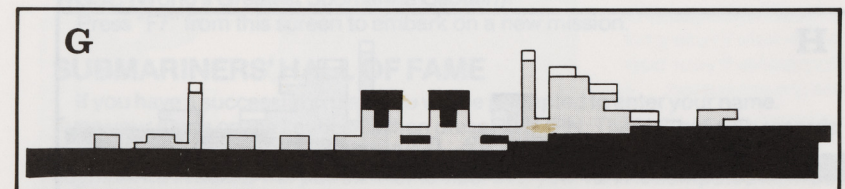

SUB CONTROL DIAGRAM and STATUS AREA

The bottom few lines of most battle station screens contain the sub control diagram and the status area. (The Atari ST and Amiga versions have mouse menus — see below.) The sub control diagram on the left is a rear view of your sub with the current rudder, dive plane and throttle settings displayed. Left and right arrows indicate left/right rudder, up and down arrows indicate up/down dive planes, and a number 0-4 shows the throttle setting. The bottom line displays your current speed (in knots), depth (in feet) and heading (in degrees). The top line is used to keep you informed of status messages from the crew.

Mouse Menu: On the Atari ST and Amiga versions, icons control rudders, depth, periscope up/down and rotate view, zoom/un-zoom, throttle (speed) and time scale. Use your mouse to point to the action desired and press the **left** mouse button to select the command.

The icon that controls rudders and depth is a four-way arrow. Select the top or bottom arrow for surfacing or diving. Select the right or left arrow for right or left rudder; select it twice for right full rudder or left full rudder. Select the **center** of the arrow to cancel all dive plane and rudder actions.

MESSAGES and SOUNDS

You may receive messages at any time from various members of the crew. Rudder, throttle, and periscope commands will be acknowledged. You will also hear the sound of your own engines, nearby ships, and torpedoes. In addition there are messages and sounds with special meanings:

SONAR REPORTS DESTROYERS CLOSING. (“ping” sound)

The sonarman is reporting that the submarine has been located by the enemy’s sonar.

SONAR REPORTS DEPTH CHARGES DROPPED. (“splash” sound)

The soundman is reporting that a destroyer overhead has dropped depth charges into the water.

DEPTH CHARGES EXPLODING! (explosion sounds)

LOOKOUTS REPORT DESTROYERS FIRING. (gun sound)

Lookouts on the bridge are reporting that enemy destroyers are in range and are firing at the sub.

SHELL HIT!! SUB DAMAGED. (whistling explosion sound)

Your submarine has been hit by a destroyer’s shell. Damage has been sustained.

BOW (AFT) TORPEDO FIRED! 135’ TRACK. (torpedo launch, torpedo motor sounds)

One of your torpedoes has been launched in the direction indicated.

DECK GUN FIRED! (gun fire sound)

You have fired your deck gun in the direction indicated.

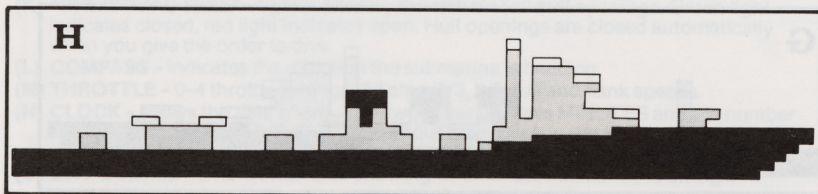

SONAR REPORTS DISTANT EXPLOSIONS. (distant explosion sound)

The sonarman is reporting a torpedo or gun hit.

WARNING: TEST DEPTH EXCEEDED. (hull creaking sound)

You have exceeded the sub’s rated test depth, small leaks are starting. (Check the Damage Reports screen.)

WE HAVE RUN AGROUND! (grinding sound)

Your sub is scraping the bottom. You will be stopped until you rise off the bottom.

REPAIRS COMPLETED.

Work parties report that they have repaired a damaged component; check the Damage Reports screen.

BLOW EMERGENCY TANK! (alarm sound)

The emergency bouancy tank has been emptied.

RAMMED BY ENEMY SHIP! (grinding sound)

You have been rammed by an enemy ship and will start to sink. This is usually fatal.

TIME SCALING

In order to ensure accuracy, all ship movement, sightings, torpedo runs, and dive rates are recalculated every two seconds of simulated game time. However, under most conditions it is desirable to speed up the action somewhat. Normally the simulation proceeds at four times real time: one minute of game time takes 15 seconds. If the “F” key is pressed, the time scale is doubled. Repeated pressing will continue to increase the time scale up to a maximum of 32 times real-time (i.e. one hour of game time will take 2 minutes at time scale 4). When the “N” command is entered, you are detected by the enemy or torpedoes are fired, the time scaling returns to normal.

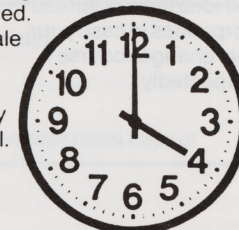

END OF MISSION, SCORING, and RANKS

Convoy Action missions end when you select the “End of Game” option. War Patrol missions end when you return to one of your bases. Either mission type ends if you are sunk or beached. In all cases you will see a screen displaying all ships which you have sunk and your final rank.

Many patrols failed to sink any enemy ships, while successful captains often sank over 15,000 tons. Your mission is to sink the highest tonnage of shipping without losing your sub. The simulation records your sinkings automatically. Your ranking will be based on tonnage sunk, difficulty level, and reality levels chosen. The higher the levels, the more value your tonnage is given. All players will rank at least Ensign. Higher levels are Lieutenant JG, Lieutenant, Lieutenant Commander, Commander, Captain, Vice-Admiral, Admiral, Fleet Admiral, and ultimately WGSC (World’s Greatest Submarine Captain)!

Press “F7” from this screen to embark on a new mission.

SUBMARINERS’ HALL OF FAME

If you have a successful cruise, you will be prompted to enter your name. Type your name on the keyboard, then press RETURN. The Hall of Fame records the best rankings achieved and also includes real-life tonnages sunk by five submarines in actual war patrols. Remember that your rank is computed from both tonnage sunk and the difficulty factors used.

CONVOY ACTION SCENARIOS

Convoy action scenarios are shorter scenarios which place you in specific historical situations. They are useful for becoming acquainted with the features of this simulation, practicing specific tactics, or when time is short.

PLUNGER IN THE INLAND SEA (Lt. Commander D.C. White)

Day/Submerged

Jan. 18, 1942, Latitude 33-30 N, Longitude 135-00 E.

Radar, Steam Torpedoes, 300 ft. hull

The USS Plunger, patrolling off the southern coast of Japan, sights an escorted cargo ship steaming east at high speed. This scenario gives you the opportunity to set up a torpedo firing solution against a moving ship. Remember that even though the Torpedo Data Computer calculates the correct lead gyro angle to hit the target, it is often a good idea to fire a spread of torpedoes in case your target changes course unexpectedly.

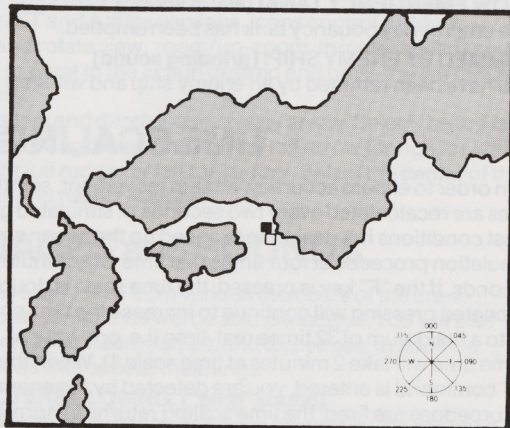

WAHOO VS. CONVOY (Lt. Commander "Mush" Morton)

Day/Surface

Jan. 26, 1943, Latitude 2-37 N, Longitude 139-42 E.

Radar, Steam Torpedoes, 400+ ft. hull

Off the New Guinea coast, USS Wahoo sights a small Japanese convoy. The situation is a submariner's dream: an unescorted convoy including a troop ship and a large oil tanker. However, the convoy has radioed for help and a destroyer is on the way! Your objective is to strike quickly and cause as much damage as possible. Be sure to use your aft torpedoes if your bow tubes are exhausted.

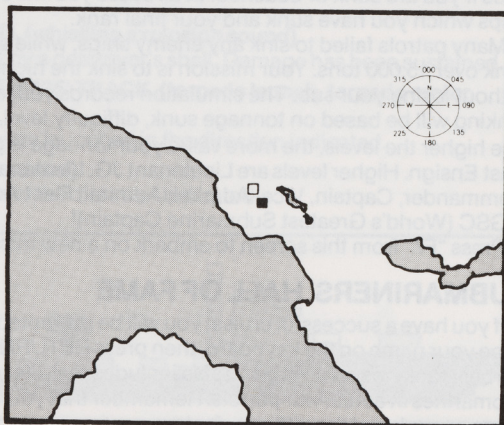

HAMMERHEAD AT BORNEO (Commander J.C. Martin)

Night/Radar

October 1, 1944, Latitude 6-30 N, Longitude 116-11 E.

Radar, Steam Torpedoes, 400+ ft. hull

SJ radar picks up a large escorted convoy as the USS Hammerhead patrols the northern coast of Borneo. The tanker, one of Japan's dwindling handful remaining at this stage of the war, should be your primary target. This scenario introduces night combat against an escorted convoy. You should take care to avoid being spotted as long as possible; use moderate speeds, keep a minimum profile toward the escort, and try to time your attack so that the escort is on the other side of the convoy.

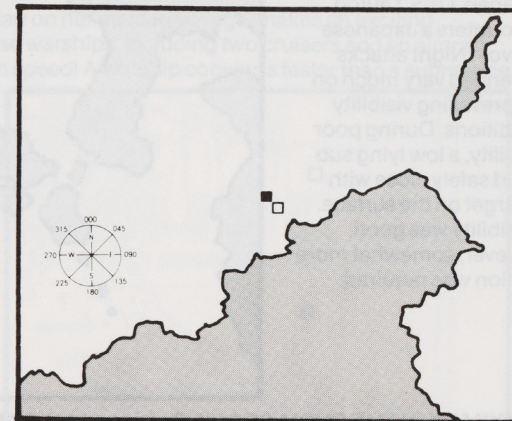

SEARAVEN AT TOAGEL MLINGUI (Commander H. Cassidy)

End around

January 13, 1943, Latitude 9-12 N, Longitude 130-38 E.

Radar, Steam Torpedoes

Somewhere between the Philippine Islands and the Japanese naval base at Truk Lagoon, USS Searaven comes across a northbound convoy. You are in a bad position: astern of the convoy in daylight. A careful "end-around" maneuver is recommended. Be sure to use the time scaling feature to speed up your run around the convoy.

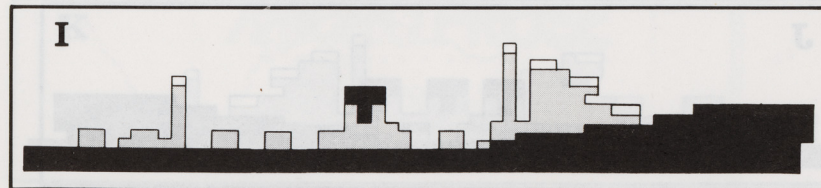
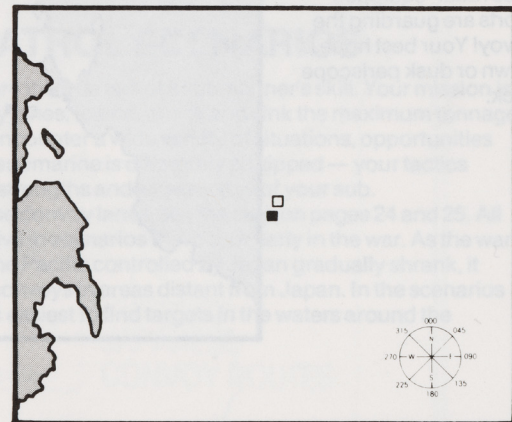

TAUTOG AT NIGHT (Lt. Commander Sieglaff)**Radar/Visual Night****March 16, 1944, Latitude 42-25 N, Longitude 144-55 E.****Radar, Steam Torpedoes, improved detonator, 400+ ft. hull**

Off the eastern coast of Japan, USS Tautog encounters a Japanese convoy. Night attacks depended very much on the prevailing visibility conditions. During poor visibility, a low lying sub could safely close with its target on the surface. If visibility was good, however, somewhat more caution was required.

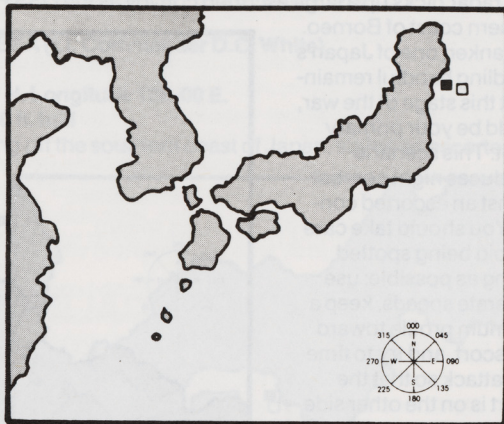
**GRAYBACK IN THE CHINA SEA (Lt. Commander J.A. Moore)****Submerged Radar****October 21, 1944, Latitude 26-48 N, Longitude 124-56 E.****Radar, Electric Torpedoes, 400+ ft. hull**

A very difficult situation. Three radar-equipped escorts are guarding the convoy! Your best hope is a dawn or dusk periscope attack.

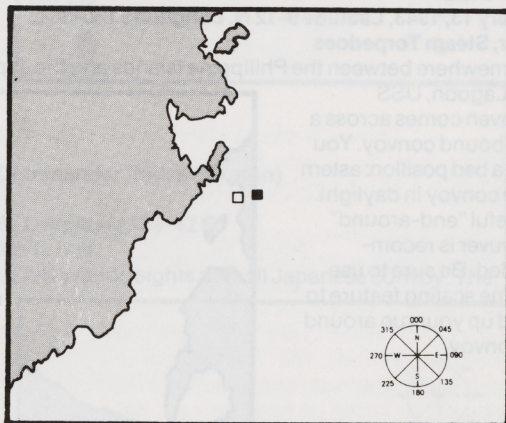
**(ATARI ST AND AMIGA ONLY)****CAVALLA HITS THE JACKPOT (Commander H.J. Kossler)****Day/Submerged****June 19, 1944, Latitude 11-50 N, 137-57 E****Radar, Electric Torpedoes, 400+ ft. hull**

Cavalla, patrolling near Palau on her maiden voyage, makes an exciting discovery: a group of Japanese warships, including two cruisers and an aircraft carrier, is approaching at high speed! A warship convoy is faster than a submarine, so you'll only have one chance to sink or cripple the big ships before they sweep on past. Your prime target should be the carrier, but if your position is too unfavorable, go for one of the cruisers. **Be wary!** The escorts are alert and dangerous, and the cruisers are deadly if you surface.

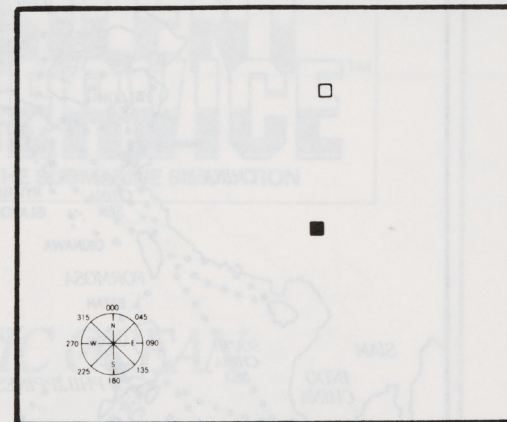
**WAR PATROL SCENARIOS**

The War Patrol scenarios are the true test of a submariner's skill. Your mission is to scour the Japanese convoy lanes; to find, attack and sink the maximum tonnage of enemy shipping. You will encounter a wide variety of situations, opportunities and dangers. Note that each submarine is differently equipped — your tactics should take into account the strengths and weaknesses of your sub.

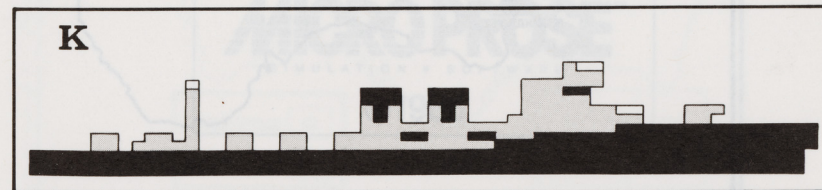
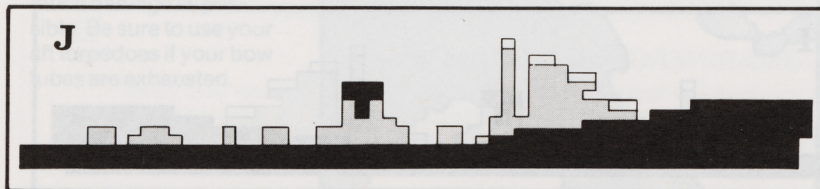

For an overview of Japanese convoy lanes, see the map on pages 24 and 25. All of these convoy lanes are active in scenarios that occur early in the war. As the war progressed, and the area of the Pacific controlled by Japan gradually shrank, it became very difficult to find convoys in areas distant from Japan. In the scenarios that occur later in the war, it is easiest to find targets in the waters around the islands of Japan.

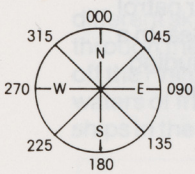



SILENT SERVICE™
THE SUBMARINE SIMULATION

THE PACIFIC OCEAN

-  U.S. SUBS
-  ALLIED BASES
-  PRIMARY JAPANESE CONVOY ROUTES

MICRO PROSE™
SIMULATION • SOFTWARE
©1985

USS TANG — Midway Patrol, June, 1944

Radar, Electric Torpedoes with improved detonators, 400+ ft. hull

The USS TANG was the second leading submarine, with 24 confirmed sinkings between Feb. 17 and Oct. 25, 1944. On TANG's third war patrol her captain took her deep into the Japanese-controlled Yellow Sea. In a span of only fourteen days, she sank ten enemy cargo ships, including four in one day! This unsurpassed achievement earned TANG the Presidential Unit Citation.

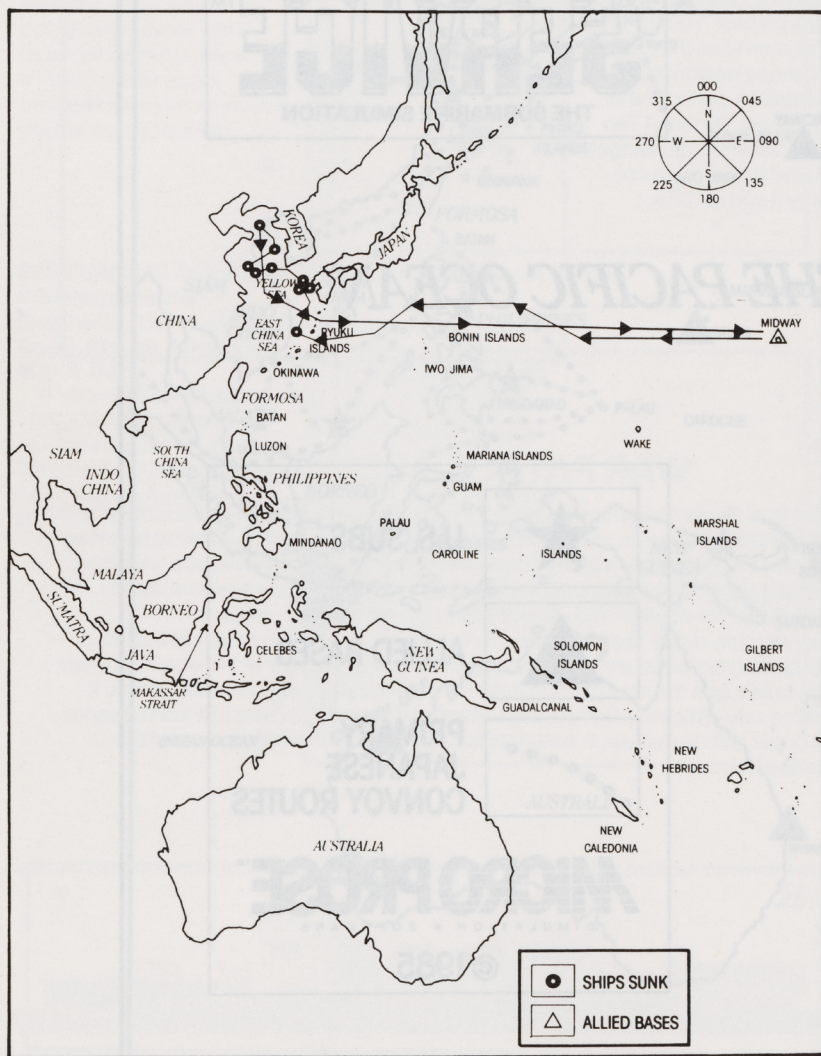

USS BOWFIN — Fremantle Patrol, November 1943

Radar, Steam Torpedoes (old detonators), 400+ ft. hull

The BOWFIN, based in Australia, sank 16 Japanese ships under four different skippers. The BOWFIN's second patrol took her from Australia, through the Makassar Strait, to the Philippines. After patrolling fruitlessly off the Philippines, BOWFIN crossed the South China Sea to the coastal waters of Indo-China. There she encountered two convoys and sank five ships in the course of three days in spite of a number of torpedo problems.



USS GROWLER — Second Patrol, August, 1942

Surface Radar, Steam Torpedoes, 300+ ft. hull

One of the first fleet-type submarines to enter the battle, the GROWLER was famed for the heroism of her captain, H.W. Gilmore. After a collision with a Japanese gunboat, Gilmore ordered an immediate dive although he lay badly wounded on the bridge, thereby giving his life to save his ship.

The GROWLER's second patrol originated in Brisbane. Off the coast of Formosa she sank over 15,000 tons of shipping — an excellent patrol at this critical stage of the war.



USS SEAWOLF — Seventh Patrol, October, 1942

Radar, Steam Torpedoes, 300+ ft. hull

Another early arrival in the Pacific, the USS SEAWOLF went on to become one of the most successful subs of the war. Her second patrol included a memorable battle against a Japanese naval force off Christmas Island.

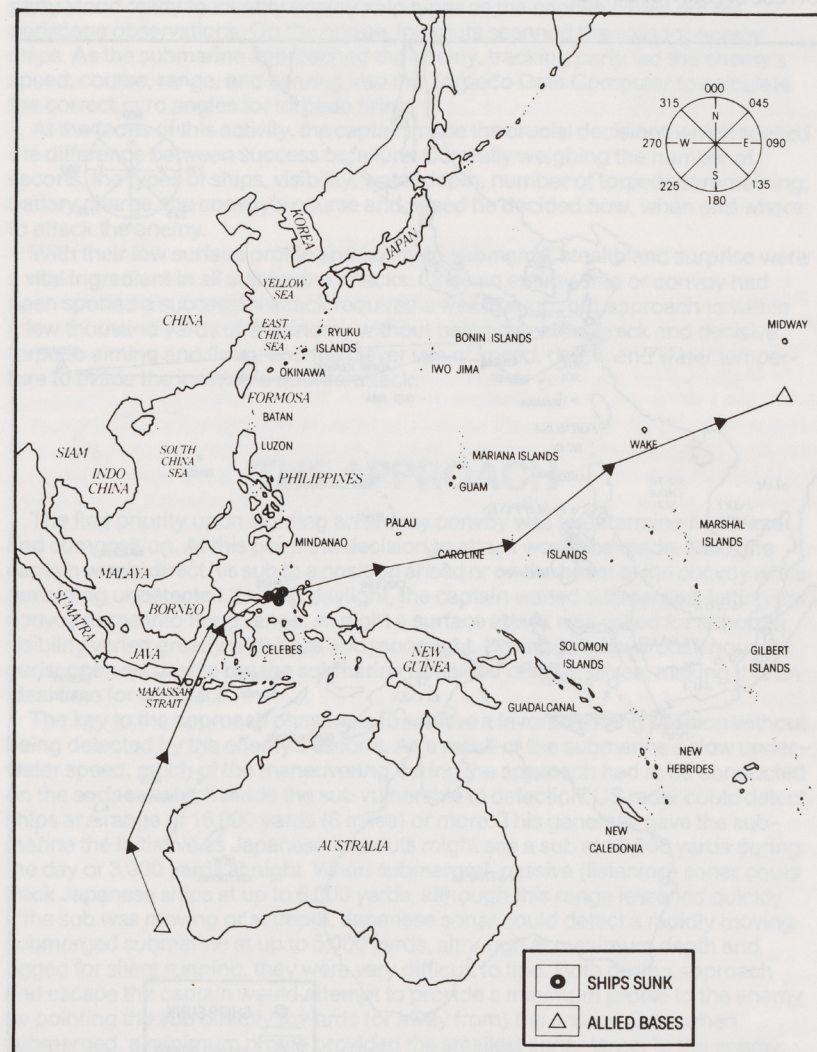

USS SPADEFISH — Second Patrol, October, 1944

Radars, Electric Torpedoes with improved detonators, 400+ ft. hull

The SPADEFISH entered the fray late in 1944. At this point in the war most Japanese escorts were equipped with radar. In spite of her late start, SPADEFISH sank 21 vessels for a total of 88,000 tons.

On her second patrol, two weeks out of Pearl Harbor, SPADEFISH happened upon a heavily escorted convoy in the East China Sea. After persistent tracking, SPADEFISH sank the heart of the convoy: the 20,000 ton escort carrier Jinya.

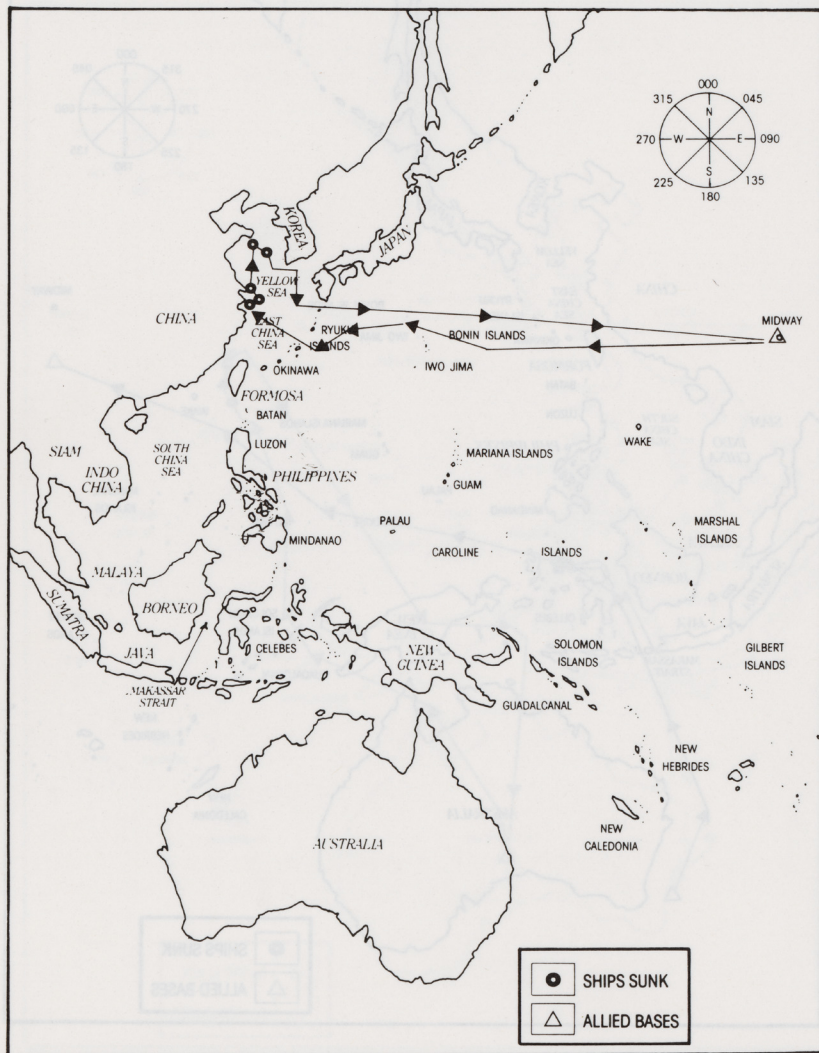

SUBMARINE TACTICS

A successful submarine attack was very much a team effort by the entire submarine crew, with the captain directing. The torpedomen and machinists mates maintained the torpedoes and engines. The soundman listened to the enemy ships through sensitive underwater hydrophones. By counting propeller revolutions and rotating the hydrophone, the soundman could estimate the enemy's speed and bearing. A radar party tracked the enemy on SJ surface radar. In the conning tower, the tracking party plotted the submarine's position and the position of enemy targets and escorts on the attack plot map. The identification party stood ready to identify enemy ship types as the captain called out his periscope observations. On the bridge, lookouts scanned the seas for enemy ships. As the submarine approached the enemy, tracking party fed the enemy's speed, course, range, and bearing into the Torpedo Data Computer to calculate the correct gyro angles for torpedo firing.

At the focus of this activity, the captain made the crucial decisions which spelled the difference between success or failure. Carefully weighing the number of escorts, the types of ships, visibility, water depth, number of torpedoes remaining, battery charge, the convoy's course and speed he decided how, when and where to attack the enemy.

With their low surface profile and ability to submerge, stealth and surprise were a vital ingredient in all submarine attacks. Once an enemy ship or convoy had been spotted a successful attack required a well thought out approach to within a few thousand yards of the enemy without being detected; quick and decisive torpedo aiming and firing; and the clever use of speed, depth, and water temperature to evade the inevitable counterattack.

THE APPROACH

The first priority upon sighting an enemy convoy was to determine its course and composition. At this point the decision to attack would be made. Next, the captain would direct his sub to a position ahead or on the beam of the convoy while remaining undetected. During daylight, the captain waited submerged, letting the convoy come into firing range. At night a surface attack was called for although visibility varied greatly with haze and moonlight. During the dawn/dusk hour the periscope was usable but the submarine remained difficult to see, making this an ideal time for an attack.

The key to the approach phase was to achieve a favorable firing position without being detected by the enemy's escorts. As a result of the submarine's slow underwater speed, much of the maneuvering during the approach had to be conducted on the surface, which made the sub vulnerable to detection. US radar could detect ships at a range of 16,000 yards (8 miles) or more. This generally gave the submarine the initiative as Japanese lookouts might see a sub at 10,000 yards during the day or 3,000 yards at night. When submerged, passive (listening) sonar could track Japanese ships at up to 6,000 yards, although this range lessened quickly if the sub was moving or at depth. Japanese sonar could detect a rapidly moving submerged submarine at up to 5,000 yards, although at maximum depth and rigged for silent running, they were very difficult to find. Both during approach and escape the captain would attempt to provide a minimum profile to the enemy by pointing the sub directly towards (or away from) the enemy. Even when submerged, a minimum profile provided the smallest sonar target to the enemy destroyers.

SUB DETECTION TABLE (10 knots)			
		DAY	NIGHT
SURFACED	DISTANCE IN YARDS	20000	3000
		8000	1000
PERISCOPE DEPTH		6000	2000
		2000	800
SUBMERGED*		2000	2000
		800	800

*if the submarine was under a temperature gradient layer, the sighting range was substantially less.

TORPEDOES

Primary submarine armament consisted of six torpedo tubes forward and four tubes aft. A total of 24 torpedoes were carried: 14 forward and 10 aft. A torpedo reload required about 10 minutes.

The Mark 14 steam torpedo had a range of 4,500 yards at 46 knots. In order to protect the submarine from premature detonation, the warhead was not armed until the torpedo had travelled 450 yards. The Mark 14 was propelled by steam generated by a spray of water passing through a torch of burning alcohol. This left a trail of bubbles on the surface which pointed back towards the firing submarine. Torpedo steering was controlled by an internal gyroscope.

These complex devices suffered from a number of severe problems. Chief among them being the tendency to run too deep, thereby passing underneath the target, and the tendency of the Mark 6 exploder not to explode on contact with the target. Both of these problems were eventually corrected as the war progressed.

In late 1944 the Mark 18 electric torpedo was introduced. This weapon ran slower than the steam torpedo, 30 knots. However it did not produce the tell-tale bubble stream of its predecessor. Sub commanders were no longer forced to escape after the first torpedo salvo. Under ideal conditions, ship after ship could be sunk as the escorts circled frantically searching for the unseen attacker.

Most torpedoes were therefore fired at a range of 1,000-3,000 yards. The best torpedo track was one which was perpendicular to the course of the target ship. This provided the largest potential target area. Head-on shots or stern shots were unlikely to hit their target.

TORPEDO DATA COMPUTER

Contrary to popular belief, the captain did not estimate an amount by which to "lead" the target. US submarines used a Torpedo Data Computer (TDC), an early-model analog device. The TDC, when fed with the target speed, range, and course, automatically calculated the correct torpedo track. The TDC calculated and fed the gyro angle directly to the gyroscope which steered the torpedoes.

The gyro angle calculated by the TDC was based on the target's maintaining a constant course and speed. The captain would often aim slightly ahead or

behind the target ship if he expected a particular change in course. Frequently a "spread" of torpedoes was fired by aiming one torpedo slightly ahead of the target, one torpedo directly at the target, and one torpedo slightly behind the target.

In this simulation the gyro lead angle is automatically added to your periscope bearing when the torpedoes are fired. Example: you have an enemy ship centered squarely in your crosshairs, bearing 090 degrees (due East). The target is on a course of 180 (South). The TDC calculates a gyro angle of 10 degrees. If you fire a torpedo it will assume a 100 degree track: (your 090 degree periscope bearing plus 10 degrees gyro angle) and should hit the target. In the same situation, if your periscope is pointed at 085 (slightly behind the target) your torpedo will assume an 095 track (85 + 10). This torpedo should pass behind the target but may hit if the target zigs or zags.

It was important to make the first set of torpedoes count. Once the torpedo tracks were spotted, the convoy would begin to zig-zag radically and the escorts would charge in on the subs position.

The captain's role during the firing procedure was to call off range, bearing, and angle on the bow information which were input into the TDC and to select the moment to fire the torpedo(es).

DECK GUN

Most US subs were equipped with a 4-inch deck gun. This gun had a range of up to 8,000 yards and a fairly rapid rate of fire. Although infrequently used, the deck gun was effective in sinking badly damaged targets or to slow a ship down and force it to fall behind the convoy. The gun was also used as a last ditch measure by subs which had been forced to surface or had suffered too much damage to dive safely.

The gun may only be fired when your sub is on the surface. Use the crosshairs on the periscope/binocular screen to aim the gun. The range is automatically set to the TDC range of the target at which you are aiming. Use the "+" and "-" keys to add or subtract deflection from this range. Example: an 18 knot destroyer coming directly towards you from 4,000 yards away will move over 200 yards in the time it takes the shell to reach the target. Therefore you should use the "-" key to select a deflection of -200 to -250 yards before firing the gun. At 2,000 yards the shell will only take half the time to reach the target, so a -100 yard deflection should be used. More than one shell may be in flight at any one time. You will see a splash of water when the shell lands. If the shell hits its target, you will see and hear the explosion. Your gun is supplied with 80 shells.

ESCAPE

If detected by enemy escorts, escape became the sub's main objective. A submarine was no match for even a single destroyer in a gun and ramming duel. The usual tactic was to dive as deeply as possible and rig for silent running. The enemy escort would circle over the last known position of the submarine, hoping to pick up a sonar echo from the submarine's hull. Maintaining a minimum profile and minimum running noise was especially important under these circumstances. A strong temperature gradient could also provide some protection from the enemy's sonar. Leaking fuel or machinery damage made the escort's job easier. Submarines gained some benefit from their tighter turning circle and ability to constantly track the escorts' propeller noises. Under extreme circumstances, a sub might try to convince the attacking destroyers that it had been destroyed by releasing oil and debris which floated to the surface.

At night the sub's 20 knot surface speed was sometimes sufficient to outrun pursuing escorts.

TORPEDO FIRING TERMINOLOGY

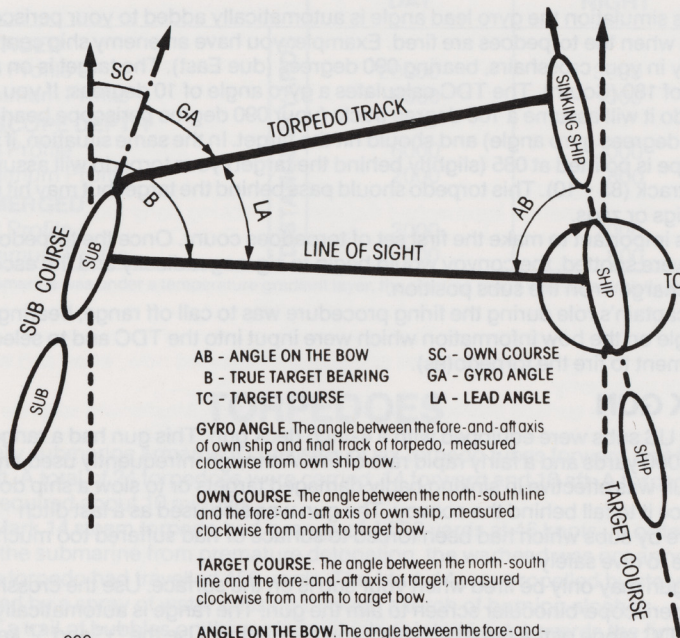

AB - ANGLE ON THE BOW
 B - TRUE TARGET BEARING
 TC - TARGET COURSE
 SC - OWN COURSE
 GA - GYRO ANGLE
 LA - LEAD ANGLE

GYRO ANGLE. The angle between the fore-and-aft axis of own ship and final track of torpedo, measured clockwise from own ship bow.

OWN COURSE. The angle between the north-south line and the fore-and-aft axis of own ship, measured clockwise from north to target bow.

TARGET COURSE. The angle between the north-south line and the fore-and-aft axis of target, measured clockwise from north to target bow.

ANGLE ON THE BOW. The angle between the fore-and-aft axis of target and the line of sight (LOS), measured from target bow to starboard or port.

TRUE TARGET BEARING. The angle between the north-south line and the line of sight, measured clockwise from the north.

LEAD ANGLE. The angle between the true target bearing and the torpedo track.

RANGE. The distance in yards from periscope to target.

TORPEDO RUN. The distance in yards which the torpedo travels from tube to target.

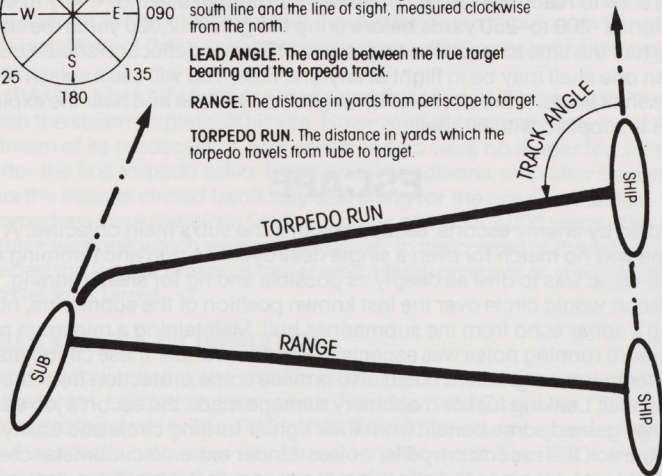
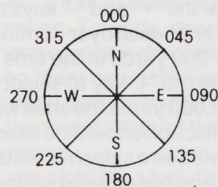

JAPANESE CONVOYS

Japanese shipping generally travelled in small convoys of three to seven ships. Occasionally, cargo ships and warships might travel alone. As the war progressed and Japanese losses mounted, increasing numbers of escorts were assigned to these convoys. Convoys may consist of cargo ships, troop ships, tankers, and destroyer escorts.

Tankers were the most important target class. The Japanese were critically dependent on the flow of oil to keep the Main Battle Fleet in operation. Troop ships were also important targets. These ships transported troops to and from their far-flung island conquests. You are more likely to find these valuable ships among the shipping lanes which lead directly to Japan.

Cargo ships represented the majority of Japanese shipping. They conveyed supplies and equipment to and from the Japanese homeland.

Escorts came in two classes: destroyers were often used for escort duty, especially in important convoys. The Japanese also constructed a special class of escort for anti-submarine defense: the "kaibokan". Both destroyers and kaibokan were armed with guns to engage submarines on the surface, sonar to detect submarines below the surface, and depth charges to sink them. A submarine on the surface could outrun a Kaibokan, which had a top speed of less than 20 knots. Destroyers could steam at close to 30 knots.

A twisting, speeding, shallow-draft escort was a very difficult torpedo target, although a single hit was generally sufficient to sink one.

Japanese convoy traffic tended to concentrate along the routes between major ports. Refer to the convoy route map for details.

JAPANESE TACTICS

Japanese escorts were formidable opponents. Their optical and sonar equipment were of excellent quality and Japanese gunnery was outstanding. The primary deficiencies were depth charges which tended to be set too shallow and the lack of surface radar until late in the war. This encouraged the night-surface attack and deep submergence as an evasion technique. The Japanese also had a tendency to give up the hunt once contact was lost, although some experienced escorts showed more persistence.

The goal of the escort was to sight an attacking submarine and to destroy or drive it deep before it approached torpedo firing range. As the escort swept back and forth across the path of the convoy, lookouts constantly scanned the seas and sonar operators searched under the water for the telltale silhouette, periscope feather, or sonar echo which betrayed the sub's presence. If a sub was sighted, all escorts charged the sub at maximum speed. An unwary sub might be caught near the surface and destroyed. A quicker adversary could still be forced to dive deep, removing it as a threat to the convoy. Once a sub had been driven under, the escorts circled the last sighting, hoping to establish sonar contact and conduct a depth charge attack.

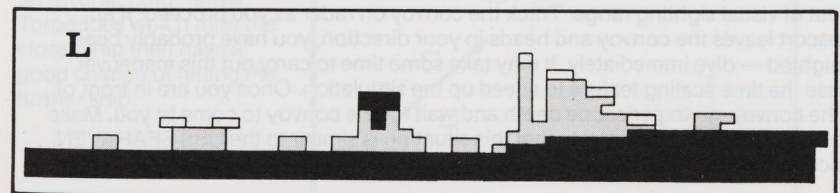

TACTICAL SITUATION PLOTS

The diagrams below will provide some sense of the combat situations faced by submarine captains. These are by no means all of the potential situations which you will encounter. They are presented here as examples of real-life submarine tactics and to assist you in surviving the myriad dangers of undersea combat.

Situation 1: END AROUND ATTACK

You are at periscope depth and have just sighted a 10-knot convoy bearing 090 degrees (due East). You determine the enemy's base course to be 045 (Northeast). It is around noon: seven hours of daylight remain. The convoy is escorted by at least one destroyer. Your torpedo tubes are full and your battery is fully charged. What is your plan?

This is a difficult situation: the convoy is steaming too fast for a submerged approach. A cautious skipper might leave this convoy alone and look for a better game. A foolhardy captain might charge in for a stern surface attack, but a surfaced submarine is no match for a destroyer during daylight.

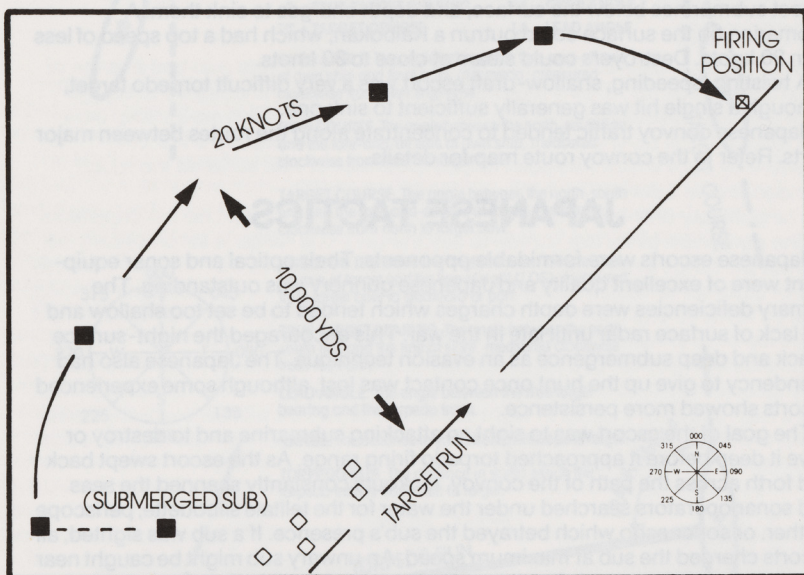

The experienced skipper would probably try the "end-around" tactic. Turn and proceed submerged away from the convoy until you are out of visual sighting range — about 10,000 yards depending on the visibility. Now surface and use maximum speed to achieve a position ahead of the convoy, taking care to stay out of visual sighting range. Track the convoy on radar as you proceed. If an escort leaves the convoy and heads in your direction, you have probably been sighted — dive immediately. It may take some time to carry out this maneuver, use the time scaling feature to speed up the simulation. Once you are in front of the convoy, go to periscope depth and wait for the convoy to come to you. Make your torpedoes count! (Note that this situation is similar to the USS SEARAVEN scenario)

Situation 2: NIGHT/SURFACE INTERCEPT

You are patrolling on the surface when radar picks up a convoy bearing 045 (NorthEast). It is a dark and hazy night. Radar determines the enemy's base course to be 180 (South) at 8 knots. Two "kaibokan" escorts appear to be leading the convoy. What do you do?

This is an excellent set up. You are ahead of the convoy and visibility is poor. Your primary consideration should be to avoid detection by the escorts as you approach the convoy. Use moderate speed and keep your bow pointed towards the escorts as much as possible. This provides only a small visual target for the enemy lookouts to detect. You should be able to reach an ideal firing position off the convoy's beam at a range of 1,000-2,000 yards. If you time your approach when the escorts are busy on the other side of the convoy, you may be able to escape on the surface: the "kaibokan" can only turn 18 knots. Good Luck! (Note that this situation is similar to the USS HAMMERHEAD scenario)

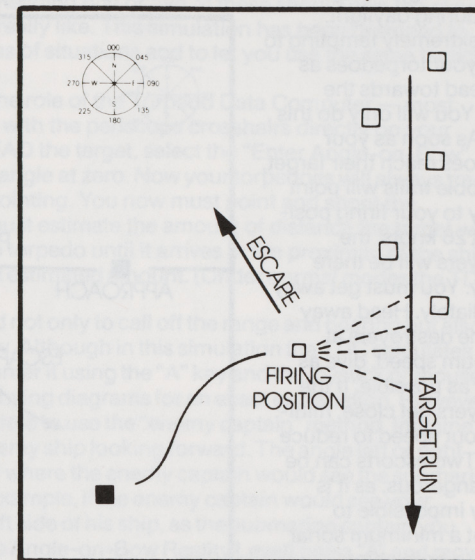

Situation 3: DAYLIGHT/SUBMERGED ATTACK

During a routine day periscope sweep you observe a convoy heading directly towards you: range 4,000 yards! An escort is in the lead and four cargo ships follow in a diamond pattern. Act quickly!

You should immediately head perpendicular to the convoy's track to put yourself into a favorable firing position for a broadside torpedo shot. Since you will be turning your broadside to the enemy you should dive to reduce the chance of sonar contact. Once in firing position, wait until the two middle ships give you an "overlapping" target. Torpedoes which miss the closer ship then have a good chance of hitting the further ship.

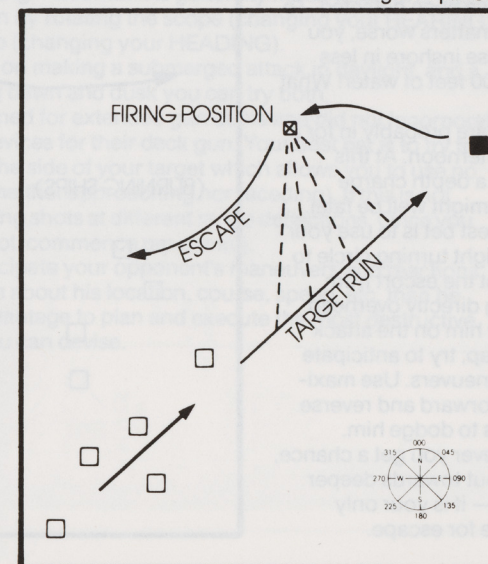

Situation 4: AVOIDING ENEMY ESCORTS

You have just loosed three steam torpedoes at a particularly juicy tanker. The two escorting destroyers have not detected your presence. You are at periscope depth during daylight.

It is extremely tempting to watch your torpedoes as they head towards the target. You will only do this once! As soon as your torpedoes reach their target, the bubble trails will point directly to your firing position. At 26 knots, the destroyers will be there quickly. You must get away immediately. Head away from the destroyers at maximum speed, dive as deeply as possible. If the destroyers get close, minimize your speed to reduce noise. Two escorts can be very dangerous, as it is usually impossible to present a minimum sonar profile to both ships.

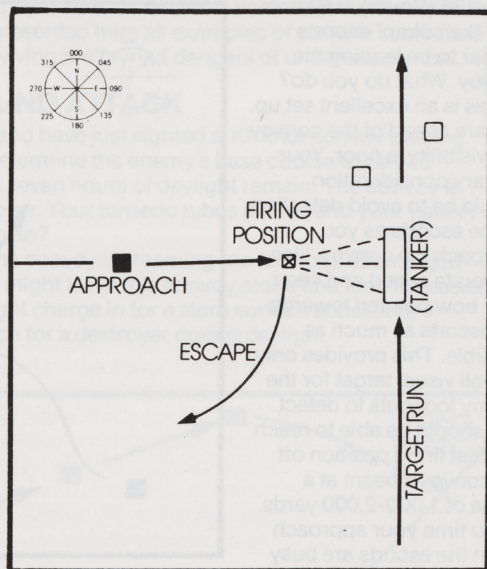

Situation 5: SHALLOW WATER ESCAPE

You are in trouble! Behind you three cargo ships are burning from a well-planned torpedo salvo. But an angry escort is charging towards you. The constant pinging leaves no doubt that you have been detected. To make matters worse, you are close inshore in less than 100 feet of water! What now?

You are probably in for a long afternoon. At this depth, a depth charge attack might well be fatal. Your best bet is to use your sub's tight turning circle to prevent the escort from getting directly overhead. Follow him on the attack plot map; try to anticipate his maneuvers. Use maximum forward and reverse speeds to dodge him. Whenever you get a chance, head out towards deeper water — it is your only chance for escape.

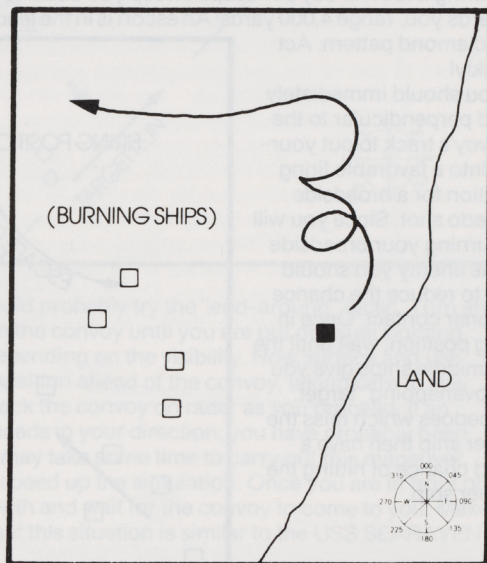

PLAYING TIPS

There are numerous books relating to World War II submarine warfare, many written by actual participants. Reading one or two of these should give the player an appreciation of what it was really like. This simulation has been designed to present you with the same types of situations and to let you use the same tactics you will read about.

Make sure you understand the role of the Torpedo Data Computer — most torpedo shots should be made with the periscope crosshairs directly on your target. If you really want TO LEAD the target, select the "Enter Angle-on-Bow" reality level and leave the gyro angle at zero. Now your torpedoes will always track in the direction your scope is pointing. You now must point and shoot the torpedoes like a gun, i.e. you must estimate the amount of distance the target will travel from the time you fire the torpedo until it arrives in the proximity of the ship. You then lead the target by that estimated amount. (Under normal modes the TDC will do this automatically.)

During WWII the Captain had not only to call off the range and bearing but also estimate the Angle-on-the-Bow. Although in this simulation the TDC calculates the angle, you are welcome to enter it using the "A" key and the joystick or mouse. You should study the accompanying diagrams for an exact explanation. However, a good way to estimate this angle is to use the "enemy captain" method. Imagine yourself on the bridge of the enemy ship looking forward. The angle left or right from the bow of the enemy ship where the enemy captain would see the submarine is the Angle-on-the-Bow. For example, if the enemy captain would see your submarine 45 degrees off the left side of his ship, as the submarine captain you would (assuming you chose the Angle-on-Bow Reality Level) press "A" and move your control until the angle reads -045 degrees. As you can see, this is an estimation procedure. By using this procedure, you are trying to solve the equation $\text{GYRO LEAD ANGLE} = \text{ArcSine}(\text{Target Speed} \times \text{Sine}(\text{Angle-on-Bow}) / \text{Torpedo Speed})$ in your head. Tricky, eh?

Make sure you understand the distinction between BEARING and HEADING. BEARING is the direction in which your scope/binoculars are looking, HEADING is the direction your sub is facing. Note that it is generally much faster and easier to aim your torpedoes and gun by rotating the scope (changing your BEARING) rather than by steering the sub (changing your HEADING).

In general, you should plan on making a submerged attack in daylight, and a surface attack at night. During dawn and dusk you can try both.

Submarines were not designed for extended gun duels and did not incorporate sophisticated range finding devices for their deck gun. Your best bet is to try to achieve a position directly to the side of your target which allows you to use no range deflection (the target is neither approaching nor receding). If this is not possible, try a number of ranging shots at different range deflections. Once you hit the target with a ranging shot, commence rapid firing.

Most importantly, try to anticipate your opponent's maneuvers and reactions. In general, you will know more about his location, course, speed, etc. than he knows about you. Use this advantage to plan and execute the most destructive and least dangerous attack you can devise.

TYPICAL U.S. SUBMARINE

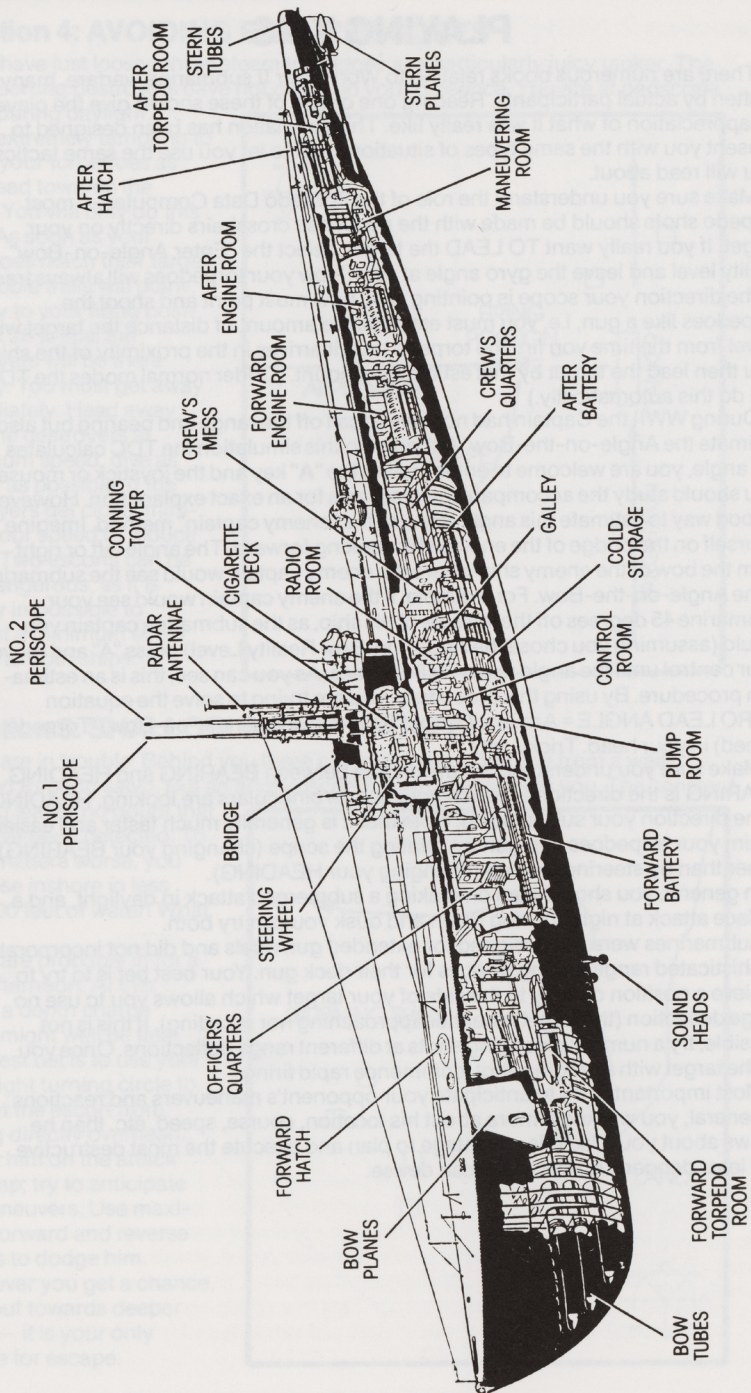

CAPABILITIES

The US Fleet Submarine of the Second World War was an outstanding weapon. With 200 tons of diesel fuel and a cruising range of 12,000 miles, no area of the Pacific was safe for enemy shipping. Four diesel engines produced 6,400 horsepower for a maximum surface speed of 20 knots. Battery driven electric motors provided submerged propulsion at up to 10 knots for short periods. The rated test depth of the first fleet submarines was 300 feet, while later craft were rated for more than 400 feet. Both were capable of somewhat greater depths under emergency conditions.

STANDARD EQUIPMENT

The WWII fleet submarine incorporated a variety of navigation, detection, and fire control devices.

The periscope could be used for visual observation to a depth of 44 feet. The scope provided target range and bearing information to the Torpedo Data Computer.

Surface Radar could be used on the surface or at periscope depth. SJ surface radar had a range of up to 16,000 yards.

Passive (listening) sonar became the primary source of information when submerged. Experienced sonar operators could determine ship speed, bearing, and estimated range up to a distance of 6,000 yards.

EQUIPMENT INNOVATIONS

At various times during the war, significant new equipment and tactics were introduced.

November 1942: US submarines were equipped with surface radar. This allowed enemy ships to be detected at ranges of up to 16,000 yards. Prior to this time, visual sightings and sonar were the only means of detecting enemy ships.

April 1943: The Japanese increase the escort strength for their vital tanker and troop ship convoys. All such convoys now contain at least one escort.

August 1943: A new stronger pressure hull on US submarines increases the maximum safe depth from 300 to almost 425 feet. This change was unknown to the Japanese who tended to set their depth charges too shallow.

September 1943: An improved detonator is fitted onto American torpedoes, greatly reducing the incidence of "dud" torpedoes.

January 1944: Mark 20 Electric torpedoes are introduced. These "wakeless" torpedoes no longer pinpoint the location of a submarine firing torpedoes. But their relatively slow 30 knot speed requires a good close-in attack position.

July 1944: The Japanese introduce radar on their escort vessels, making surface attacks much more difficult.

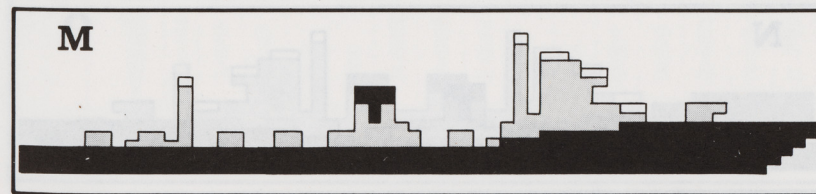

SUBMARINE WARFARE IN THE SOUTH PACIFIC

The American fleet submarine was a complex and formidable war machine, ideally suited for the vast reaches of the Pacific and the far-flung Japanese convoy routes. American submariners developed an aggressive doctrine which frequently took them into the heavily travelled waters off the coast of Japan. Sub skippers vied to surpass each other in ships and tonnages sunk. As the war progressed, US sub strength grew from a handful of antiquated craft to a powerful striking force of over two hundred vessels. The ranks of the sub commanders were also transformed as the pressures of undersea warfare weeded out the peacetime sailors and forged an elite cadre of young, aggressive, and skillful captains.

The history of submarine warfare in the Pacific is the story of these men and the highly trained crews they led. Each patrol, each attack was a personal confrontation between these men and a skillful and determined enemy. The Allied victory in the Pacific was in no small measure a consequence of their overwhelming success.

TYPICAL TORPEDO

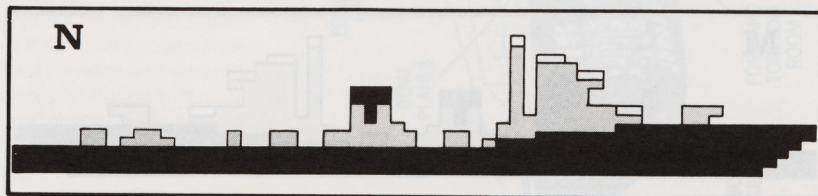
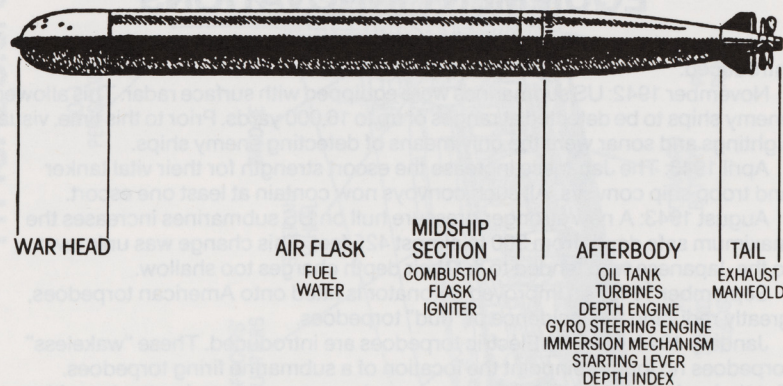

U.S. SUBMARINES IN THE SOUTH PACIFIC

EMERGENCE OF THE U.S. SUBMARINE: Operational submarines date back to the time of the American Revolution, but it was not until the Second World War that the "Silent Service" came into its own as an essential part of the American armed forces.

Early efforts at submarine combat were beset with many problems. Submarines were deployed during World War I, but saw little action. The years that followed brought limited budgets, limited interest and U.S. sub development became a low priority item. The Japanese military, in contrast, had been constantly at war since the beginning of the 1930s. They enjoyed superior weapons and numbers, and their troops were battle-tested and combat ready. The Japanese sank a number of U.S. carriers and came close enough to the American West Coast to shell several targets there, including Los Angeles.

Japanese leaders were not infallible. Those leaders with first-hand knowledge of the vast industrial potential and internal resources of the U.S. were ignored by the majority of the Japanese military elite – a fatal lapse for a small island nation, heavily dependent on a vital shipping force. The Japanese also underestimated the strength and range of the 1930s vintage American subs, which were nearly a match for the Japanese I-boats at the beginning of the war. Compounding this shortsightedness was a deeply ingrained sense of racial superiority on the part of the Japanese. This arrogance would prove costly as the war progressed, and the Japanese military would not acknowledge the growing proficiency of the U.S. submarines and the men who commanded them.

The early days of WWII undoubtedly reinforced the Japanese sense of superiority. The inexperienced American sub fleet got off to a lackluster start, in large part due to uncertainty and disagreement over what their place in the war effort should be. As adjuncts to surface craft, subs were more active, but still were not encouraged toward independent action. Official policy at the time called for caution; sub captains were admonished not to be aggressive or to take chances. The lack of tangible success lowered crew morale and raised doubts about submarine effectiveness in the war effort.

DEVELOPING SUBMARINERS: Command inertia was not the only problem. It became clear that the special rigors of submarine service required a special captain and crew. The special situation of submarine service called for a different class of fighting man. Stern disciplinarians were not necessarily the best commanders; an aggressive and flexible kind of leader was needed to handle the myriad of situations a submarine faced. As for those of the crew, a more stoic, "get the job done" mentality proved more valuable in the tense conditions of sub warfare than cowboy bravado. An understanding of submarine psychology was a large step forward in improving submarine success.

TORPEDO TROUBLES: The lack of an effective and reliable torpedo plagued American forces throughout the war. Initially the poor showing of subs in combat with the Japanese was attributed to human error. Some naval officials, as well as the Bureau of Ordnance, had fully supported the Mark XIV torpedo and its

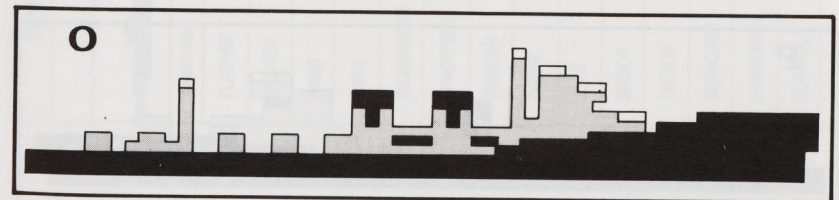

Mark VI exploder. The Mark VI incorporated a magnetic detonator in addition to the conventional contact detonator in order to increase the torpedo's effectiveness against large, heavily armored craft. Laboratory testing proved very successful, but in actual combat situations, a chorus of complaints arose from sub commanders from across the fleet. An impasse arose with the torpedoes builders and backers on one side and the sub captains on the other. These captains claimed the torpedoes were running much deeper than they should, missing the target. When they did stay on course, the torpedoes often exploded prematurely or failed to explode at all. The Bureau of Ordnance continued to blame the performance of the sub crew for the problems, despite mounting evidence that something was indeed wrong with their torpedo. Once thorough testing was done, a faulty firing pin mechanism was discovered. When the torpedo had struck its target dead on, the firing pin was crushed in such a way that it could not trigger the explosion. Ironically, perfect sighting had usually resulted in a poor performance record for the submarine crew. Once the problem was conceded, the sub fleet was held in higher esteem by those in command. As performance levels rose, so did the morale of the submarine crews. Even so, the performance and scarcity of torpedoes hampered sub operations throughout the war.

THE BALANCE SHIFTS: By 1943, the balance of Pacific power was shifting to the Americans' favor. Broader combat experience and more effective subs and torpedoes were gradually putting the U.S. on the offensive for the first time. The Japanese remained a dangerous enemy—retaining an edge in experience and torpedo technology that they would keep throughout the war. Still, the lack of internal resources was taking its toll. Their earlier successful conquests had strung the Japanese forces on islands across the Pacific, making their convoys of supplies even more important to Japanese success. The Americans recognized this vulnerability and successfully exploited it to defeat Japan.

Fully half of Japan's 6,000,000 tons of shipping were required just to sustain their civilian population. U.S. forces gradually closed in on Japan, choking off the supply arteries essential to the Japanese war effort. American subs sank nearly 3,000,000 tons of Japanese shipping, nearly half of what they had at the war's beginning. By the close of 1944, U.S. boats dominated the Pacific. With Army Air Corps bombers and carrier planes, U.S. subs could strike at will in nearly every corner of the Japanese empire.

The Japanese continued to suffer from a shrinking force of capable fighting men and morale was crippled by continued bombing of the Japanese homeland, something their warlords had promised would never come to pass.

The Japanese forces were still dangerous, but their grip on the Pacific was irrevocably broken. The question in terms of time and lives yet lost remained, but American victory was now a certainty.

The war in the Pacific was the crucible which transformed the American submarine from a vague conception of uncertain worth into a full-fledged and eventually invaluable component of the American armed services.

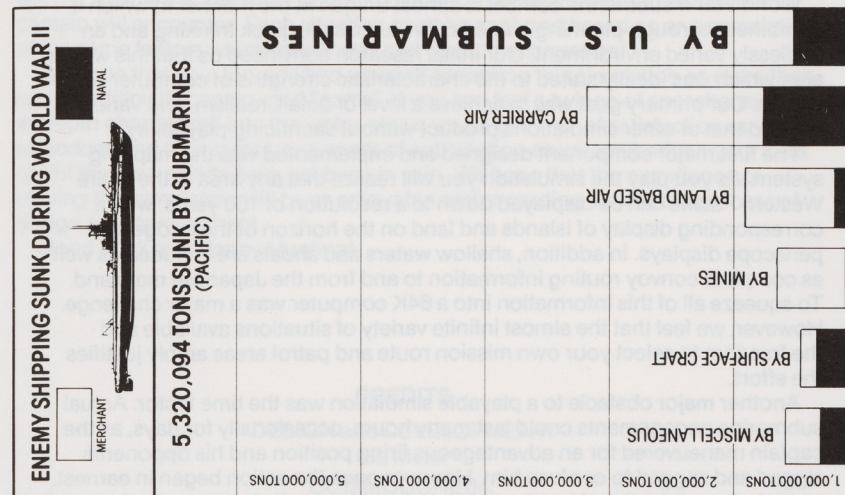
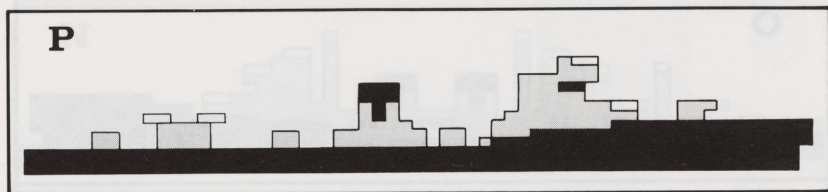

SUBMARINE LEADERS IN WWII	THE TOP 15		
	SUBMARINE	TONNAGE SUNK	SHIPS SUNK
FLASHER	100,231	21	
RASHER	99,901	18	
BARB	96,628	17	
TANG	93,824	24	
SILVERSIDES	90,080	23	
SPADEFISH	88,091	21	
TRIGGER	86,552	18	
DRUM	80,580	15	
JACK	76,687	15	
SNOOK	75,473	17	
TAUTOG	72,606	26	
SEAHORSE	72,529	20	
GUARDFISH	72,424	19	
SEAWOLF	71,609	18	
GUDGEON	71,047	12	

DESIGNER'S NOTES

World War II submarine combat is almost unique in the manner in which it combines thorough planning, rapid action, luck, skill, quick thinking and an endlessly varied environment. Our initial research convinced us that this was an area which was ideally suited to the characteristic strengths of computer simulations. Our primary goal was to achieve a level of detail, realism, and variety beyond that of other simulations product without sacrificing playability.

The first major component designed and implemented was the mapping system. As you play the simulation you will realize that any area in the entire Western Pacific can be displayed down to a resolution of 100 yards, with a corresponding display of islands and land on the horizon of the bridge and periscope displays. In addition, shallow waters and shoals are included as well as complete convoy routing information to and from the Japanese mainland. To squeeze all of this information into a 64K computer was a major challenge. However, we feel that the almost infinite variety of situations available and the freedom to select your own mission route and patrol areas amply justifies the effort.

Another major obstacle to a playable simulation was the time factor. Actual submarine engagements could last many hours, occasionally for days, as the captain maneuvered for an advantageous firing position and his opponents zigged and zagged to confuse him. However once the action began in earnest, torpedo runs were timed in minutes and seconds; a well aimed depth charge attack could swallow up a submarine with one devastating explosion. One solution might have been to adjust sighting ranges, movement scales, turning rates, etc. to produce a "bathtub" simulation with continuous torpedo firing, depth charging, and frantic maneuvering. However this would have negated many of the tactics and skills required of real submarine captains and defeated our initial design goals. Instead we implemented a time scaling system which allows the player to accelerate the progress of the simulation while maneuvering for position and still continue to accurately track all activity.

This simulation actually maintains two distinct "points-of-view" as the situation develops. The computer continuously tracks all ships, torpedoes, and your sub. This information is then filtered to provide the player with the sub commander's "point-of-view"; information which is not available to the sub commander is hidden (enemy ships which are out of range, the enemy's base course, etc.). The computer also constructs a "point-of-view" for the Japanese escorts and cargo ships — only providing them with the information which they would actually know.

Finally, we included an almost endless variety of situations, options, and play variations. On patrol missions you will encounter large and small convoys; escorted and unescorted convoys; shallow waters; day, dusk, and night attacks; and a limitless variety of tactical problems. Each of the reality levels adds a new consideration into your planning and decision making. Equipment variations also require significant tactical adjustments.

The most satisfying aspect of designing and testing this product was the opportunity to learn and use realistic submarine tactics. "Cookbook" solutions will not handle the immense variation of tactical problems the aggressive sub captain will encounter. Each situation must be analyzed based on an appreciation of the same factors which influenced real-life sub encounters.

The most satisfying aspect of designing and testing this product was the opportunity to learn and use realistic submarine tactics. "Cookbook" solutions will not handle the immense variation of tactical problems the aggressive sub captain will encounter. Each situation must be analyzed based on an appreciation of the same factors which influenced real-life sub encounters.

We hope that you, too, will find yourself accepting this simulation as more than just an artificially constructed "game". If you can feel a twinge of apprehension as depth charges roll into the water above you, a glimmer of satisfaction as your torpedoes find their target, or a spark of anticipation as you embark on your next patrol then our efforts have not been in vain. We hope that the experience of playing this simulation will be as enjoyable and rewarding as was the process of design and development.

Good Luck and Happy Hunting!

CREDITS

DESIGN and DEVELOPMENT:

Sid Meier

COMMODORE 64:

Sid Meier

APPLE:

Jim Synoski

ATARI XL/XE:

Randall Masteller

IBM/TANDY:

Randall Masteller

ATARI ST:

Silas Warner

AMIGA:

Russell Finn

GRAPHICS:

Sid Meier, Michael Haire

DOCUMENTATION:

Sid Meier, Michael Haire, George Geary, Bill Stealey, Lawrence Schick

PLAYTESTING:

Stephen Byrne, Jay Trotta, Gerry McMahon

SPECIAL THANKS TO FORMER SUBMARINE OFFICERS

Frank Shakespeare

U.S. Naval Academy, Class of 1953

Served on USS Requin, SSR 481

Gold Medalist, U.S. Rowing Team, 1952 Olympic Games

Alan R. Thornton

U.S. Naval Academy, Class of 1967

Served on USS Robert E. Lee, SSBN 601

COVER ART:

David Phillips

COPYRIGHT NOTICE

COPYRIGHT 1985 BY MICROPROSE SOFTWARE, INC. ALL RIGHTS RESERVED

This manual and the computer programs on the accompanying floppy disks, which are described by this manual, are copyrighted and contain proprietary information belonging to MICROPROSE SOFTWARE, INC.

No one may give or sell copies of this manual or the accompanying disks or of listings of the programs on the disks to any person or institution, except as provided for by the written agreement with MICROPROSE SOFTWARE, INC.

No one may copy, photocopy, reproduce, translate this manual or reduce it to machine readable form, in whole or in part, without the prior written consent of MICROPROSE SOFTWARE, INC.

Any person/persons reproducing any portion of this program, in any media, for any reason, shall be guilty of Copyright Violation, and shall be subject to civil liability at the discretion of the copyright holder.

WARRANTY AND LIABILITY

Neither MICROPROSE SOFTWARE, INC. nor any dealer or distributor makes any warranty, express or implied, with respect to this manual, the disk or any related item, their quality, performance, merchantability, or fitness for any purpose.

It is the responsibility solely of the purchaser to determine the suitability of the products for any purpose.

To the original purchaser only, MICROPROSE SOFTWARE, INC. warrants the media to be free from defects in material for 90 days. If during that period a defect should occur, the software may be returned to MICROPROSE SOFTWARE and we will replace the media at no charge to you. If at any time after the initial 90 day period your media becomes defective, the media may be returned to MicroProse Software, and we will replace disks for a \$10 service charge. To ensure identification as the original purchaser, please complete and mail the attached Registration/Warranty card.

In no case will MICROPROSE SOFTWARE, INC. be held liable for direct, indirect or incidental damages resulting from any defect or omission in the manual, or other related items and processes, including, but not limited to, any interruption of service, loss of business, anticipated profit, or other consequential damages.

MICRO PROSE™
SIMULATION • SOFTWARE

MicroProse remains committed to bringing you high quality, real-life simulations which provide excitement, challenge, and learning. We hope that you will enjoy this product and other MicroProse products in the future.

MICRO PROSE
SIMULATION • SOFTWARE

2, Market Place, Tetbury, Gloucestershire GL8 8DA

Tel:(0666)54326

Fax:(0666)54331 Tlx:43422MPS UK G